

THE ART OF FALLOUT 3



VDSG HARDCOPY

Conceptual imagery influencing production design and visual implementations for reference for future generations.

**VAULT 101
ARCHIVE ROOM**

CONCEPTUAL IMAGERY

(Volumes iii-xiii)

Do not remove from the archival room. An archivist is available to assist with all reference inquiries.



THE ART OF FALLOUT. 3



INTRODUCTION	3
PIP-BOY	14
COSTUME DESIGN	17
CREATURES	33
ROBOTS	45
WEAPONS	53
HARDWARE	61
THE WORLD	71
STORYBOARDS	91

© 2008 Bethesda Softworks LLC. All Rights Reserved.

Fallout® 3 © 2008 Bethesda Softworks LLC, a ZeniMax Media company. Bethesda Softworks, Bethesda Game Studios, ZeniMax and related logos are registered trademarks or trademarks of ZeniMax Media Inc. in the U.S. and/or other countries. Fallout, Prepare for the Future and related logos are trademarks or registered trademarks of Bethesda Softworks LLC in the U.S. and/or other countries. All Rights Reserved.



INTRODUCTION

Adam Adamowicz, our concept artist, drew a lot of stuff. He managed to do this, always with a smile, while Todd, Emil, and myself hemmed and hawed over every sketch, usually requesting yet another iteration. This alone is quite the achievement, but the real achievement is an extensive collection of wonderful designs that capture the spirit of the Fallout universe in loving detail. This book's goal is to give the reader a peek at a rich collection of artwork that our art team has been privileged to work from during Fallout 3's production.

Pre-production began with a series of paintings we commissioned from Craig Mullins. These were focused on the "big picture," mainly atmosphere and scope...something to provide inspiration for how various locations in the world would feel emotionally. Color palettes, sense of scale, and density of destruction were the elements we tried to capture with these, and the final in-game result is fairly faithful to these concepts.

The next step was to go down a long list of costumes, creatures, weapons, and environments that would need detailed drawings for our mesh builders to work off of. Early in the project we spent quite a lot of time iterating through a few key designs, such as the Vault suit and Pip-Boy, but as time went on we didn't have the luxury to do 20 drawings for each asset, and the pace picked-up considerably. There isn't much in the game that wasn't conceived beforehand. Anyone who works with Adam will soon come to appreciate the speed at which he can get through a lot of material while maintaining a sense of humor and creativity that was essential for the world of Fallout 3. Enjoy!

-Istvan



D.C.

The urbanized area in and around downtown Washington D.C. is a key location in *Fallout 3*. We wanted the player to feel a sense of foreboding as he explored a dense concrete jungle of streets and alleyways. The palette was kept cool and blue, sky always overcast, to contrast sharply with the stark warm sunlight of the wasteland.

Given that we were designing the aftermath of a devastating nuclear war, we did a bit of research to see just what would be left standing after such a holocaust. The answer is, not much. So the decision was made early on that we would take some liberties with the level of destruction so that enough interesting "stuff" would still be left standing for the player to explore. This meant quite a few of the structures, although heavily damaged, would still be intact to provide locations for dungeons and the like. We treated the urban zones of our world map as a large, multi-sectioned outdoor dungeon, using destroyed buildings and walls of concrete rubble and rebar to wall off various zones, or cells, that we would interconnect via underground subway tunnels.

These paintings give a sense of the level of detail we wanted to capture, in order to have a realistic sense of destruction and decay throughout the city. They provided the world artists a benchmark to hit in terms of realistic object density, something that required a few creative tricks in order to have environments like this run smoothly in the game's engine.





PRE-PRODUCTION

RIVET CITY





PRE-PRODUCTION

7



PROJECT PURITY





PRE-PRODUCTION

WASTELAND

The antithesis to downtown D.C. is the open wasteland, which comprised the vast majority of Fallout's real estate. The rule is bright, wide open spaces instead of the dark claustrophobic streets of the city. The challenge was re-envisioning the wastes as they would appear on the east coast, instead of the western desert-like locales from the previous games. We wanted it to feel similar, but look appropriate for the new location. Our version was made up of treacherous rocky terrain, with coarse dirt, mud, and burnt tree husks littering the landscape.

There's plenty of dried and dead grass and shrubs, but no healthy green plant life to be seen anywhere. It's very likely that a great deal of plant life would return after a few years and probably thrive in the real world, no matter how irradiated, but it was an appropriate stylistic decision to keep the world dry and brown in order to fit in with the classic Fallout aesthetic.

Even with these atmospheric paintings as a reference, it took time for our wasteland to come together in-game. Early on it was far too sparse and barren to be interesting enough from a gameplay perspective, with distances too great between the various scattered points of interest. But as the world art team iterated through hundreds of cells by hand, adding many additional details and locations, the wasteland quickly became an exciting place to wander and explore.

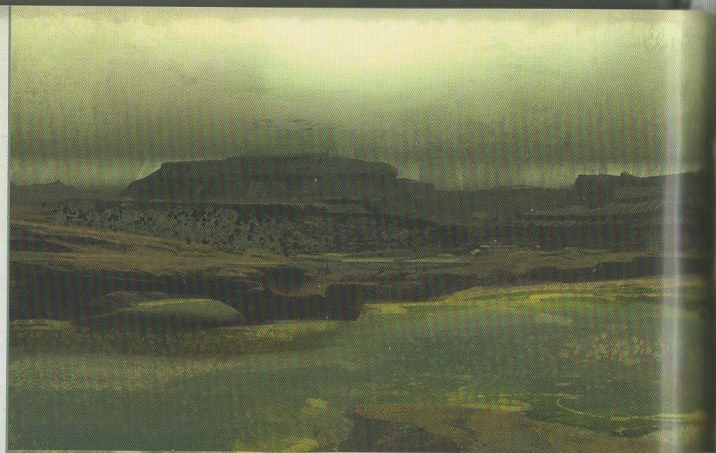



PRE-PRODUCTION

11



PARADISE FALLS





PRE-PRODUCTION

13

PIP-BOY

The Pip-Boy was one of the first three iconic elements we wanted to nail-down in terms of look and feel, the other two being the Vault suit and Brotherhood of Steel power armor. This was a good exercise in determining the approach we would take for all industrial design in the game; a blend of classic 50's aesthetics with a futuristic twist. This is a delicate balance; swing too far towards the retro and you end up with something campy and unrealistic, but too far with the futurism and you risk a generic look.

After much iteration the design was eventually narrowed down to a basic look. Once Adam's drawings all start looking too similar we know we've honed in on the most likely design. The overall design isn't too over-styled, as this is meant as a tough piece of field equipment. The device clamps on the user's arm, fastened via bolts (which implies that it doesn't come off very often). It prominently features a bulky mini-CRT display, hooded to prevent glare from the hot wasteland sun. There are various buttons and knobs, slightly oversized to facilitate handling with a gloved hand. The grill indicates that the circuitry within can get pretty hot, and proper ventilation is required. Also note the gloved hand with a control-box mounted on the back, it has a large knob and coiled wire connecting with the main unit. That knob is the primary controller for the user to manipulate the on-screen cursor. It's only years later that I realized we should have put the knobs and control on the right side of the screen as opposed to the left, this would have been considerably more ergonomic. Oh well, ergonomics were never a priority in design for this era.

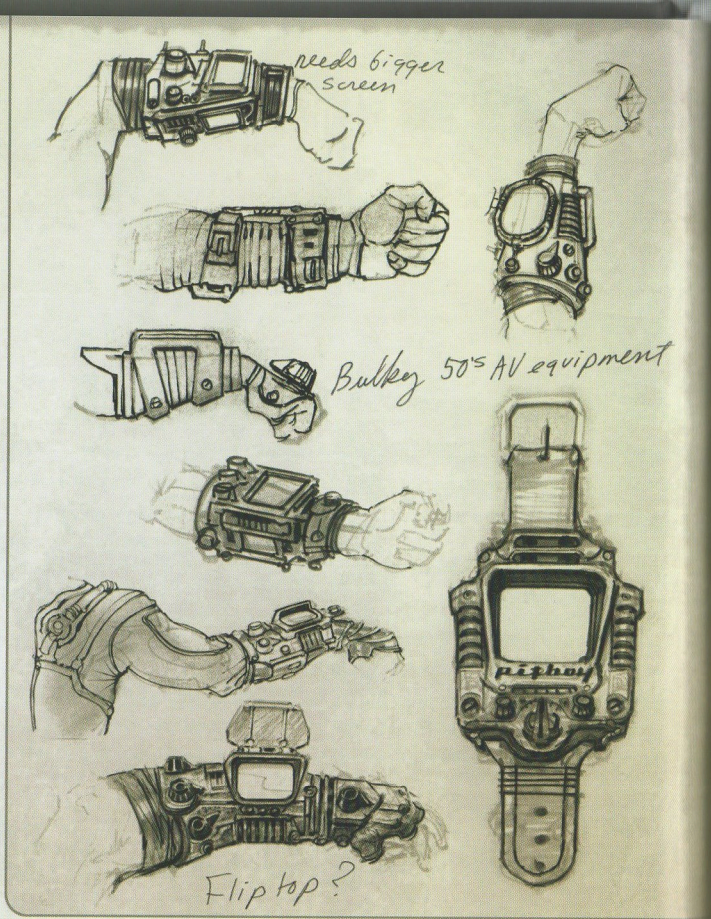

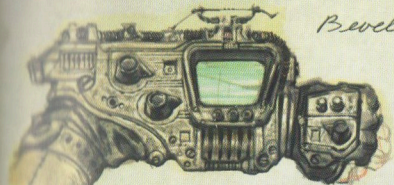

Beveled edges



worn for life, not easily removed

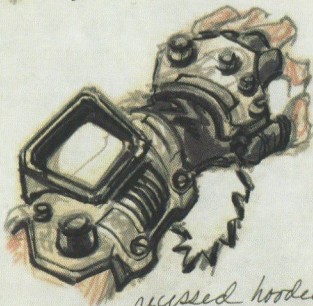
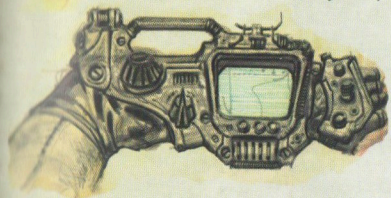
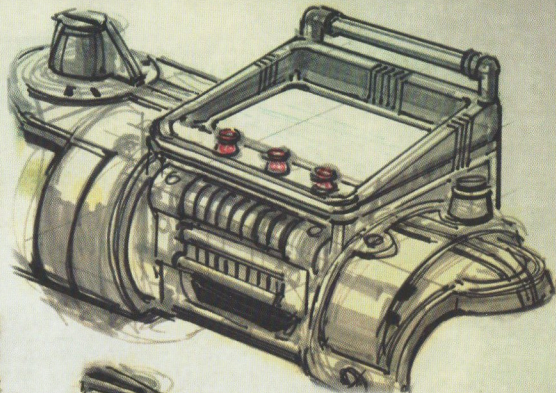

rusted hooded screen

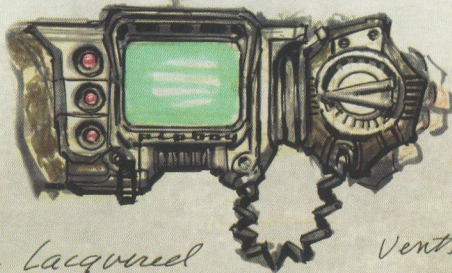
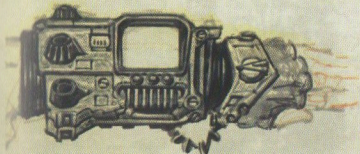
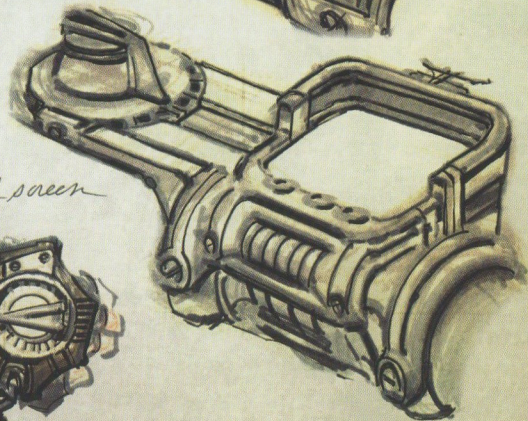
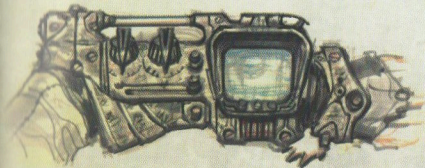

Stainless steel, lacquered

Vents decorative, functional



CROSS SECTION - PI1207

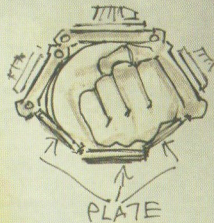
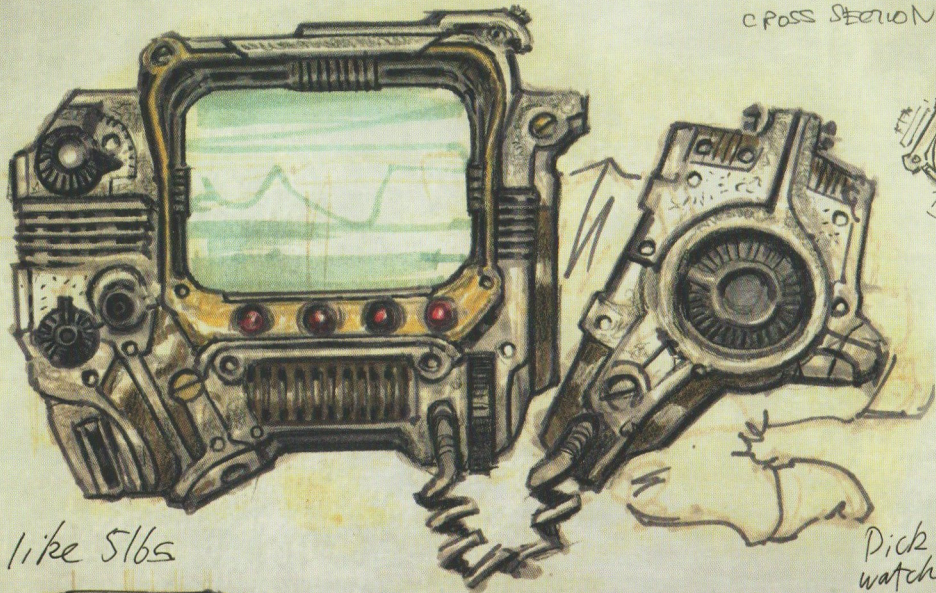
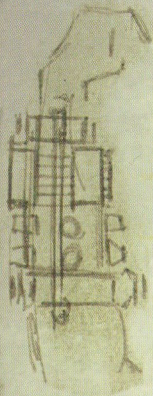

weighs like 5lbs

Pick Tracy's watch on steroids

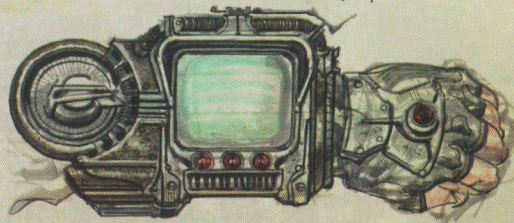
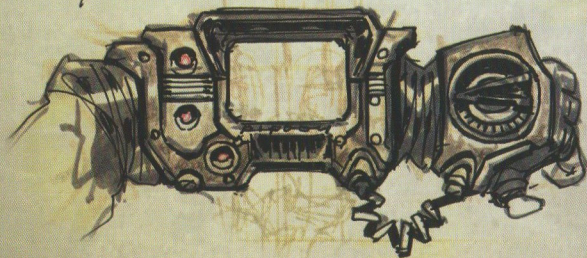

COSTUME DESIGN

Designing the various outfits and armors for the world's inhabitants was challenging. Early on we made the decision to have all apparel be one-piece suits, with only the headgear being a separate object. This allowed Adam considerable freedom to come up with some creative designs that would otherwise be impossible if we had to make sure all boots, pants, gloves, shirts, and coats would be fully interchangeable. Modularity, while fun for the player, can sometimes be an artist's nightmare.

The Brotherhood of Steel power armor was the first costume to be designed, and it was done entirely in 3D, skipping the concept art stage. This was an important piece to get right, as it had to feel true to the original, yet freshened and updated for this game's unique aesthetic. The other critical costume was the Vault suit, which Adam did more sketches for than any other design, as it also had to be just right. We've included just a sampling of this costume's many iterations.

When it came time to do the many different surface dweller costumes, such as wastelanders, raiders, slavers, merchants, etc, we sought to combine prewar style clothing elements with the scavenged remains of just about any object a person might find scattered about the wasteland. Most of the survivors are opportunists that will make do with whatever is handy, and this resulted in some very interesting and original clothing combinations. I'm proud of just how many of these crazier designs made it into the game with very little compromise.



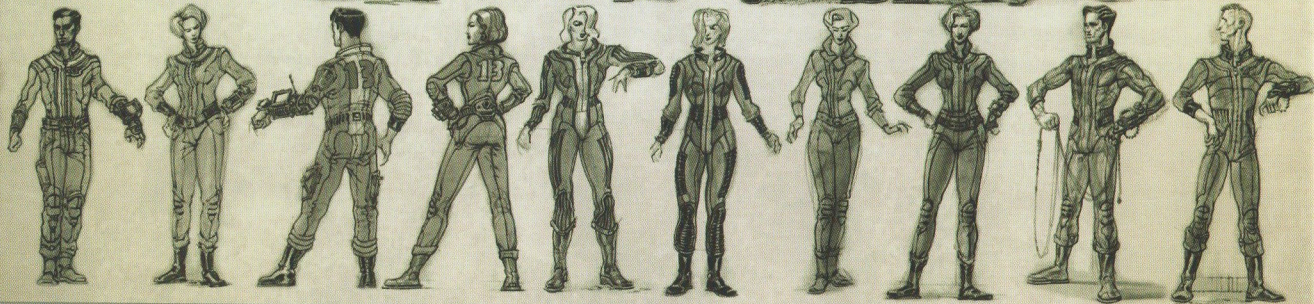
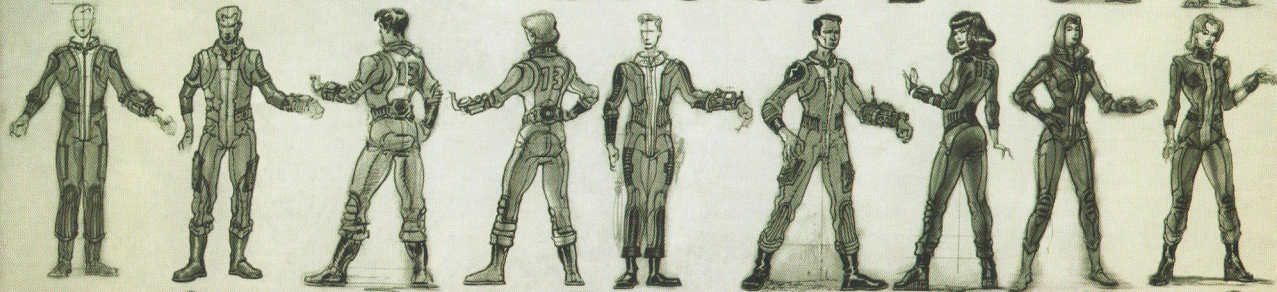
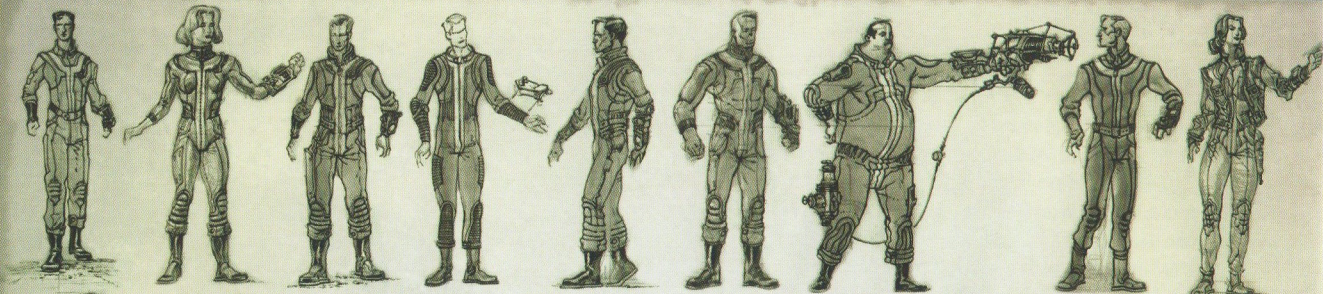

Female cut more curvy
tucked at waist



Padded
knee

Denim like material
Heavy durable stitching

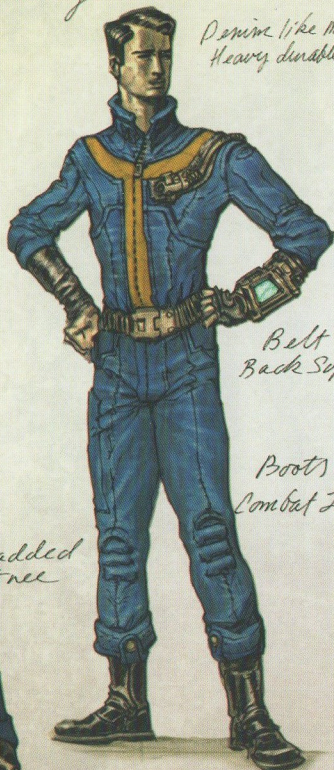

Belt =
Back Support,

Boots =
Combat Loafer

Vault Suit = durable denim
w/ forbidden planet piping on
seams,

LOGO - TUNNEL SNAKES
= VINTAGE TATTOO-ish
- HOME MADE FEEL

SOUND ON
VARSITY LETTER
STYLE

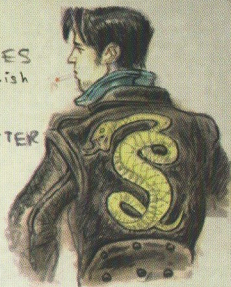

Sci Fi
Mechanic





CLOTH
GAITER



THIN STRIP OF LEATHER
OR
CARDBOARD

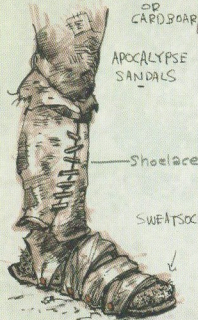

APOCALYPSE
SANDALS

Shoelace

SWEATSOCK

MEGATON:
FALL LINE-UP



DAVING
WIFE
REPAIR
JOBBS



LITTLE LAMP LIGHT: kids (costumes),
Stolen from adults





WASTELAND CLOTHING -
LOOTED, Mismatched incongruous
gear practical surreal combos,

MEGATON SETTLERS COSTUMES

Vestiges of American Culture
with survival aesthetic



WHITING GEAR
"PUNKIFIED" LIKE
DICK CAPERS



She
wants
to
Live



WASTELAND MERCHANT

PAWN -
RUMMAGE
SALE
aesthetic



Sleeves
sown
on
pockets

Beat up baseball
cap

Distowel
scarf

Photographer vest
vest worn
over long
coat

Compasses/
Watches

Leather apron

faded/repaiRed
Blue jeans

broken
cycle boots

GIVE SO'S BRAND CLOTHING
THE POST HOLOCAUST
TREATMENT...



LONDON
FOG

CHINOS
DICKIES

Stein
Mannliche

Willie Lomas goes CIA!



Mr. Burke



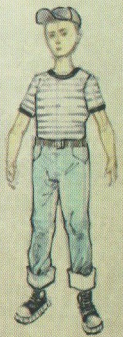
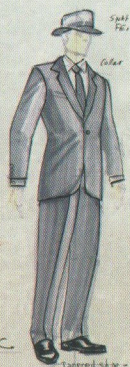
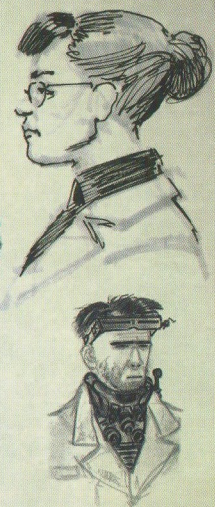
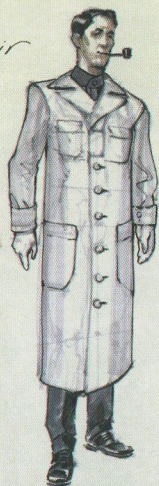

SUBURBAN COSTUME/PRE-APCALYPTIC



Motorcycle Cop Helmet
SLAVER FEMALE



Natural Predators
of Squares



Cheerleader Braid/Trophy

SLAVERS = stolen Police Gear v.s.
Rockabilly aesthetic
Trophy Motor Trench as Jewelry
50's Biker
girls Roller Derby



SLAVER MALE

ViewMaster as Goggles

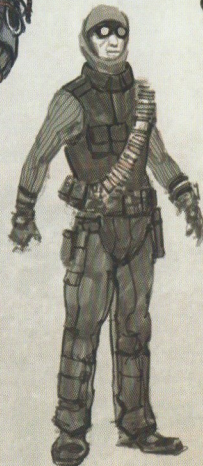

LEATHER ARMOR:
Female



The Classic

- Bits of Vintage foots all equipment



LEATHER ARMOR
: Male

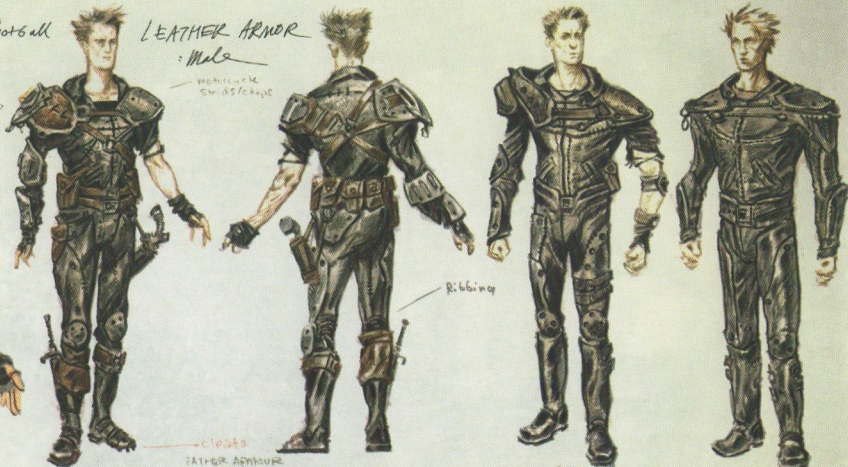

Nail savored
Rolling pin

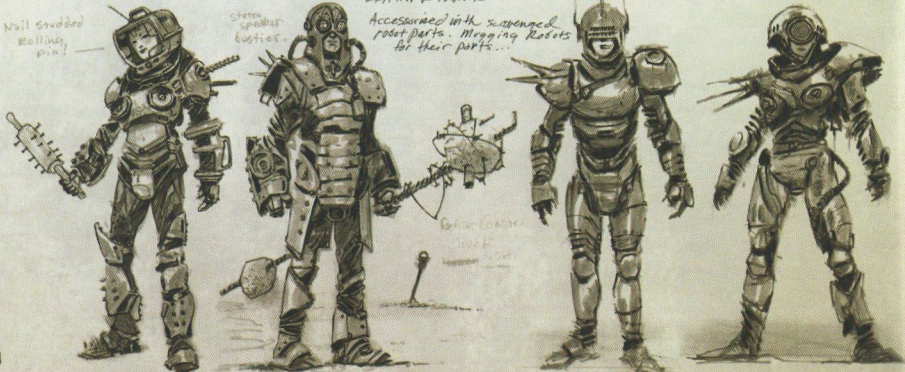

Helicopter/Jet fighter helmet
Racing harness straps

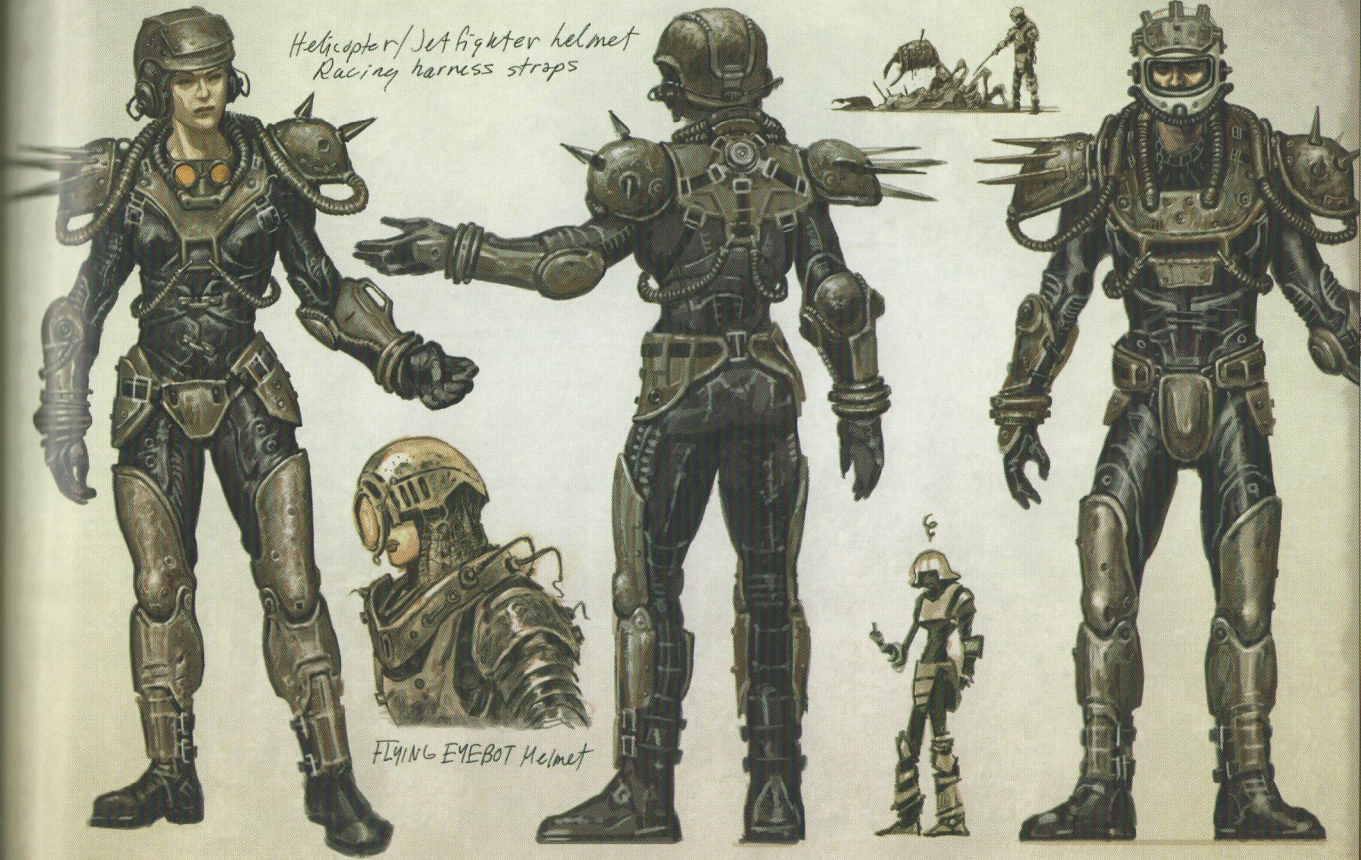

FLYING EYEBOT helmet





WW II era
futuristic
GI

Combat armor



COLONEL AUTUMN: Titus Andronicus?



Vault Security
- Riot gear

Chinese Command Uniform





Broken Glass

trophies?
food?

Auto Floor Mats
Pouches

Raider Garb/Armor

LEATHER
Vintage Padd. any

AIR
FILTER

SEAT
BELT
VINYL

LEATHER
VINTAGE
F BALL
JOCK /
DIRTY WHITE LACES

HAMMERED
OUT
CAR METAL /
WASHER
SCREW
SPIKES

BRAHMIN
LEATHER

CORRUGATE
SHEET METAL

CARPET
INSTALLATION
KNEEPADS

TAR BLACK
ENED
CAUZE

OVERALL EFFECT
BACKENED FROM
FRAM GAME, CORE,
CARBIDE C.

W capors wrapped in
fmb wire

RABID

Auto Floor
Mats
Pouches



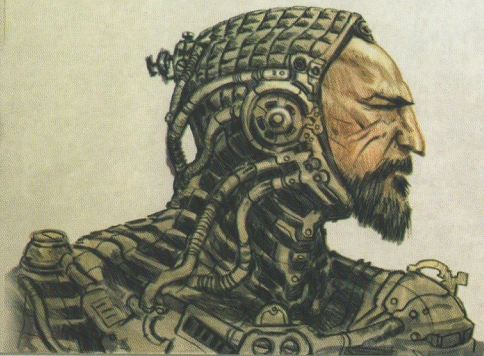

Under suit - asbestos heat protection
vacuum seal - joint attachments



ENCLAVE ARMOR

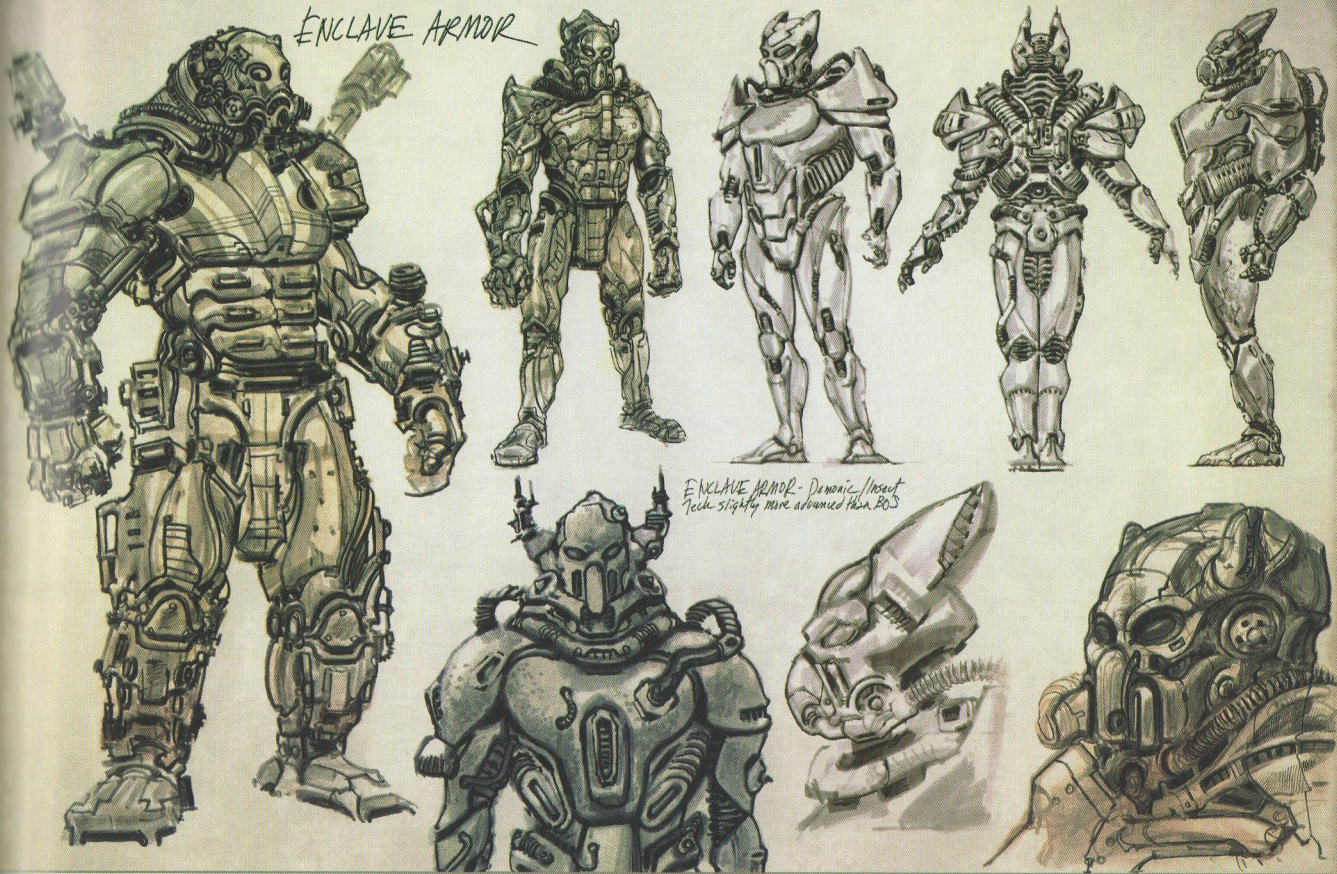

ENCLAVE ARMOR - Demonic / insect
feels slightly more advanced than PDS



Enclave Armor
like BOS armor gone
ten years ahead and
Evil, insectoid, not knight

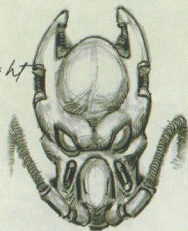

Enclave Regular
Enlisted



hightech, =
more flowing
lines

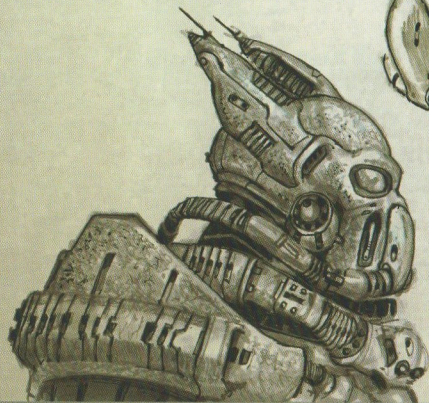

CREATURES

Adam's approach to designing a creature is to start with its personality. From the player's perspective, in the midst of an intense battle as he fends-off slashing 10-inch claws with a tiny 10mm pistol, the personality may not be the most critical element in determining how best to kill or not be killed. Yet it's this thoughtful process of determining a beast's origins, evolutionary path, maybe hopes and dreams, that results in a convincing design that is a cut or two above "generic monster."

Many of *Fallout*'s creatures fall into the category of mutation by radiation, a broad category that has many subtle variations. Mutated by FEV, in the case of a Super Mutant. By far too much extensive exposure to radiation, such is the plight of the Ghoul. Or just really bad skin from just, well, hanging out outside too much, as seems to be the case with almost everybody in this world. Our texture artists had an interesting time painting these subtle variations.

There have been many creature designs in many movies and games, and staying fresh and original with our particular menagerie was quite challenging at times. Luckily, the previous games offered a great deal of good genetic material to work from, and having the opportunity to try and update these classic designs was a real treat for the art team. And yes, Mirelurks are heavily mutated blue crabs. We are in Maryland, afterall. These guys capture the B-movie "guy-in-a-monster-suit" spirit beautifully.

A few of these sketches were for creatures that never quite made it into the game. Can you guess which ones?





Swollen udder for gross out factor, very important



Vestigial limbs or parasitic twin

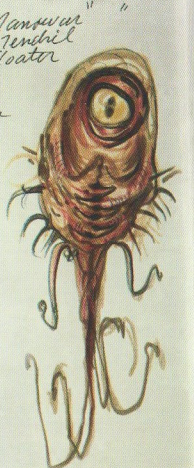

"Mammoth" "Residual Floater"

BRAMMIN

Marooned Alien



Rad Roach

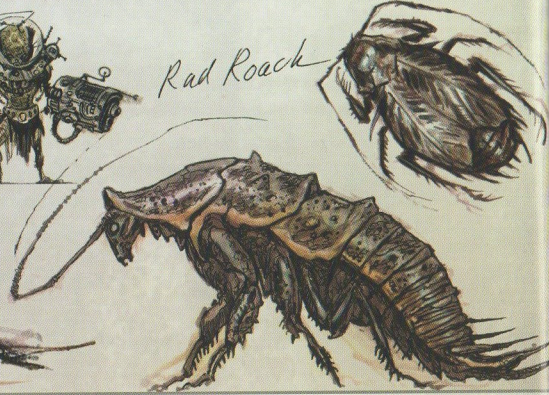

Red Scorpion



Maggot Dart:
Propelled from abdomen
BLOATFLY →

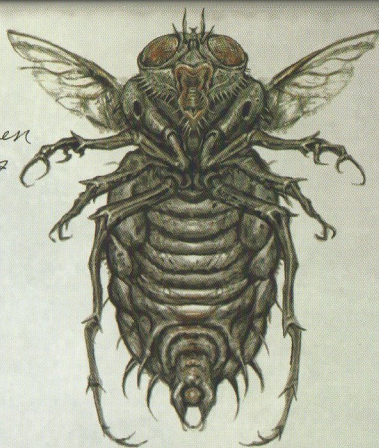

"Needle
Tooth"
Floater

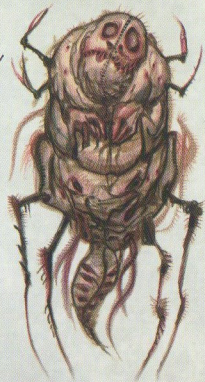

Lamprey
Floater



Molerat

Cute?





field note:
DEATHCLAW -
Demonic appearance
often mistaken
as such by the
devout...



DEATHCLAW

Death Claw bringing down a Brahmin (natural prey)

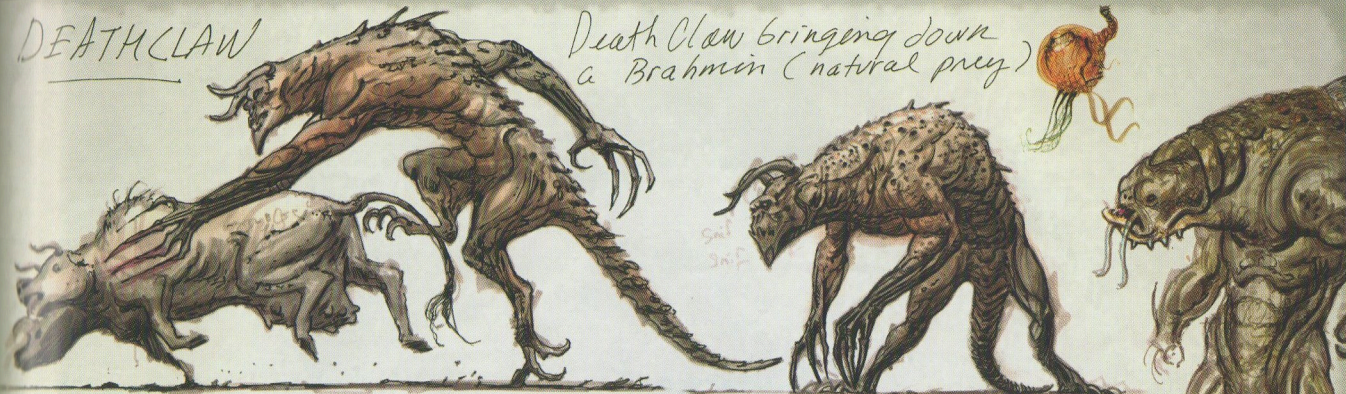

Yaoqwai

"clothesline attack"

Catfish Mielnik

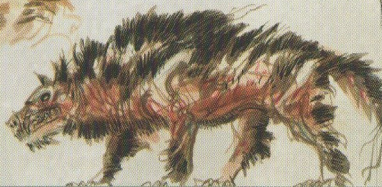



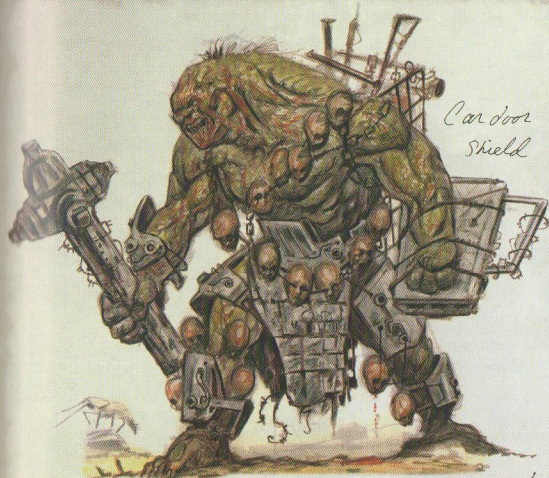

*Cardoor
shield*



Snacks →



Behemoth!



*engine block
flail*



*Shopping Cart Backpack
food torder*



In the throes of FEV mutation



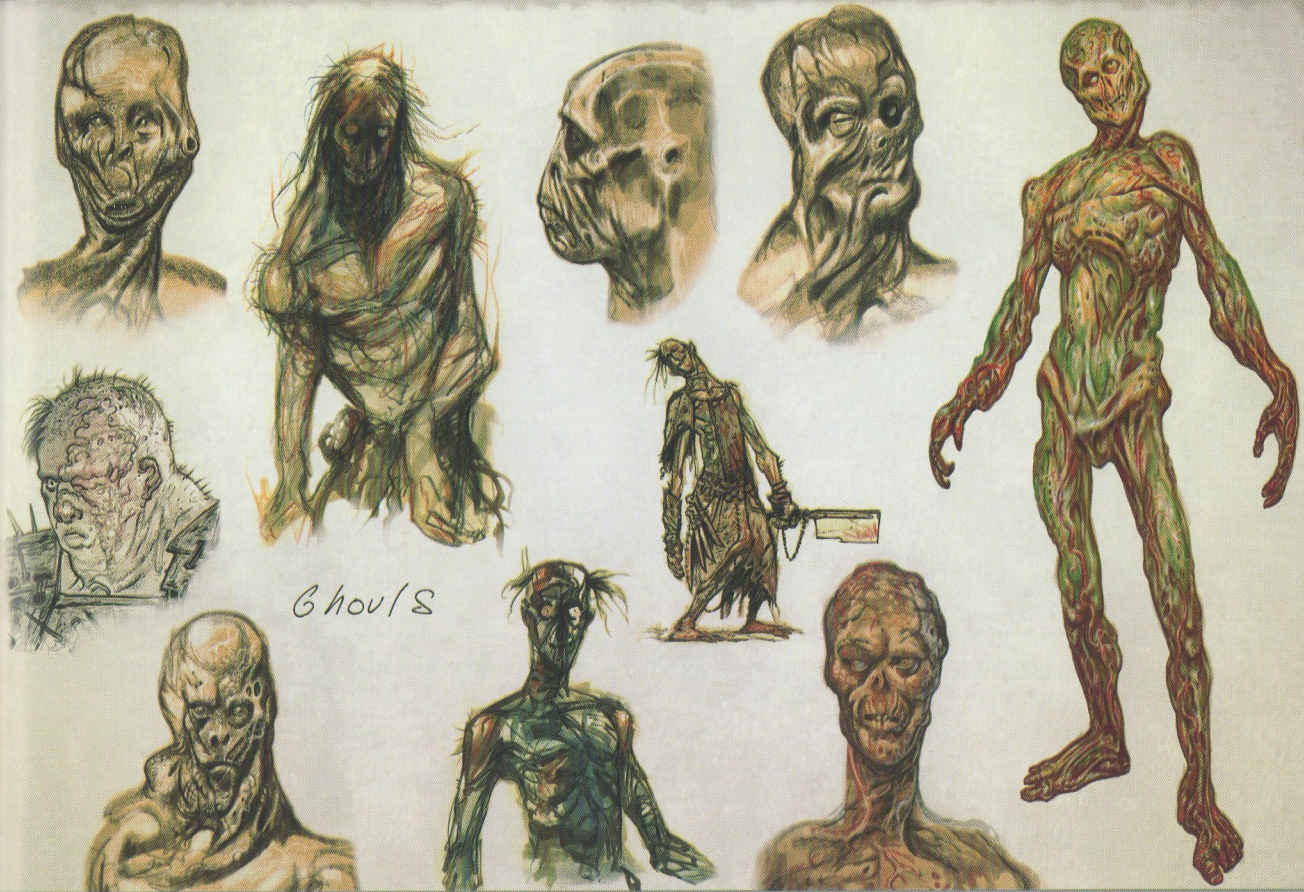

Ghouls



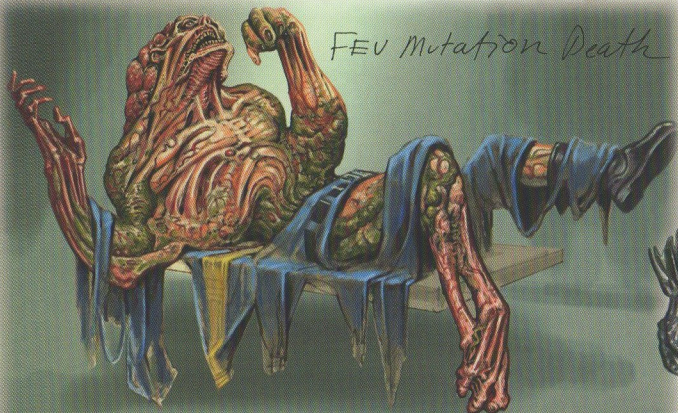

FEV Mutation Death

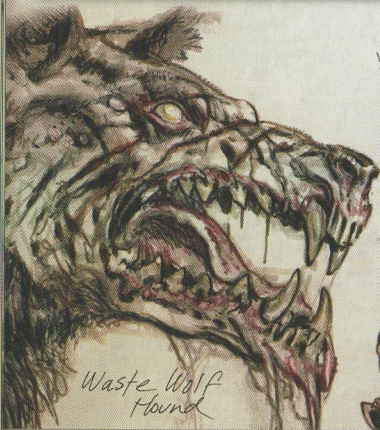

Waste Wolf
Hound

WANDAMANGO:

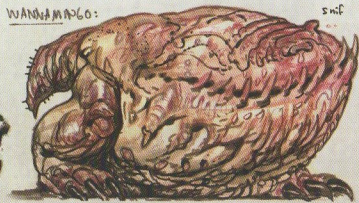

snif

Snapping turtle Variation

Mirelurk: Amphibious



Centaur

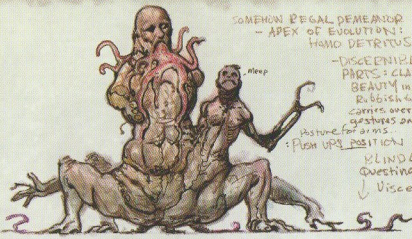
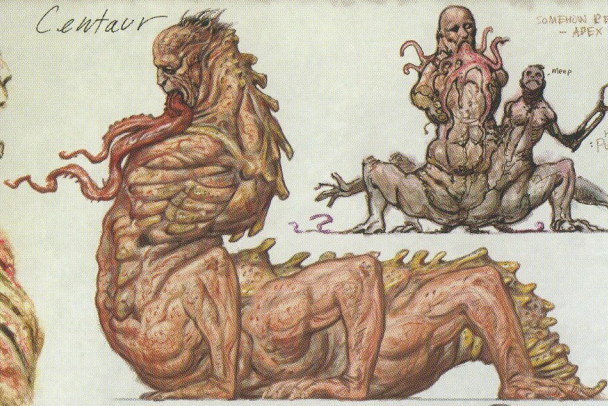
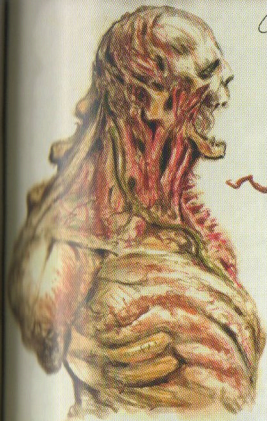

SOMEHOW REGAL DEMEANOR
- APEX OF EVOLUTION:
HOMO DESTRUXUS
- UNDESIRABLE
BEAUTY IN A
RUBBICKY W
CARDS AND NO
gestures and movement
- PLEASANT POSITION
- BLINDLY
QUESTING
↓ Viscera



*Yogoqwai / Bear
Mutation*



*Radiation
aggravated pelt
condition = very
cranky*

Wirelurk: Crab

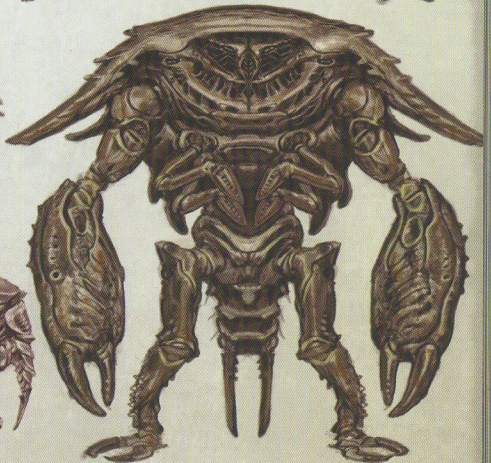

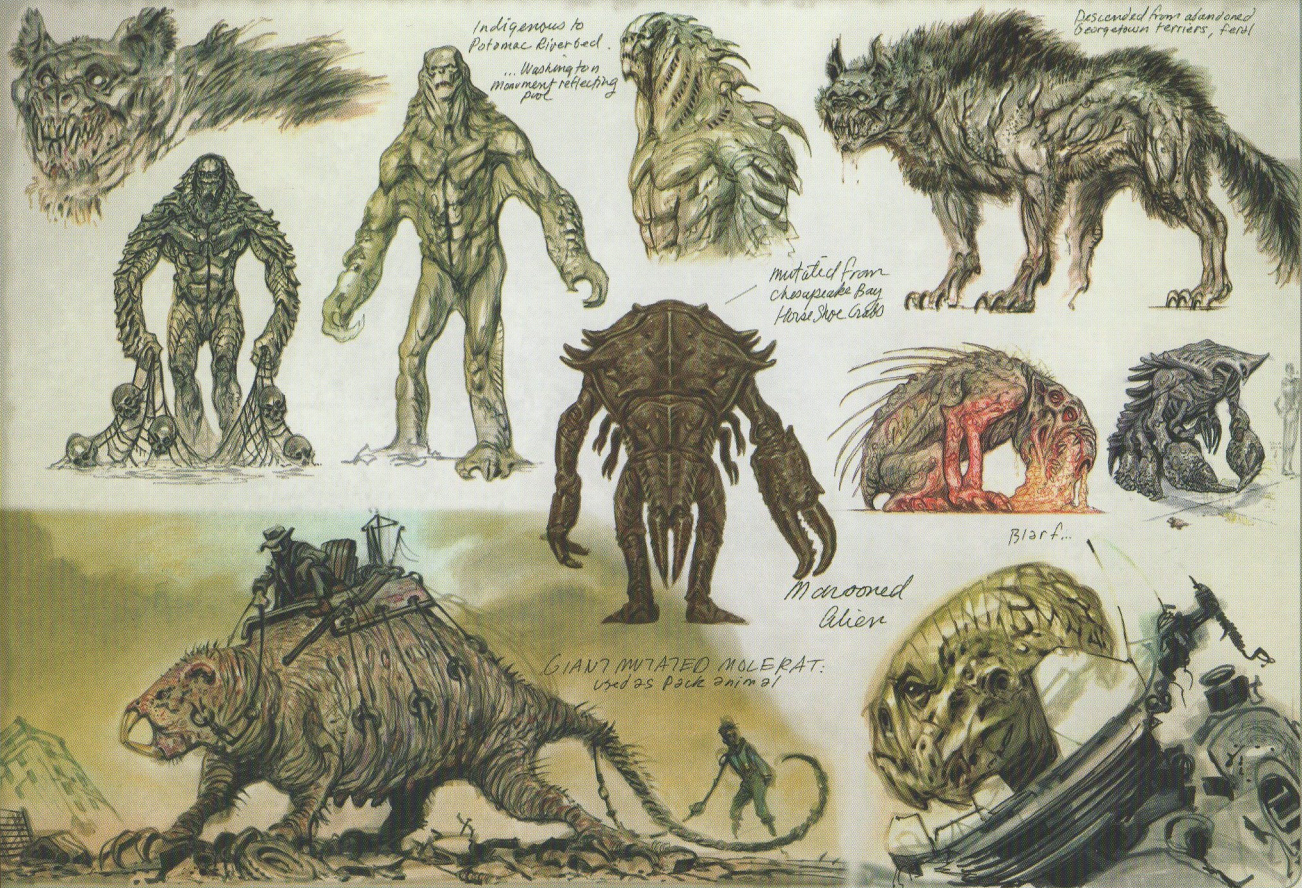

Indigenous to
Potomac Riverbed.
... Washington
Monument reflecting
poor

Descended from abandoned
Georgian ferriers, ferri!

Mutated from
Chesapeake Bay
Horse Shoe Crabs

Blarf...

Marooned
Alien

GIANT MUTATED MOLE RAT:
Used as pack animal

ROBOTS

Emil's input on every robot was "make it more like Robby the Robot!" and this was the mind-set we had in approaching the various mechanical creatures in the world. For many robots that carried over from the previous games, we tried to stay true to the original design, as with Mr. Handy and the Robobrain. Where we did diverge the reason was to better fit the robot's basic design premise. For example Mr. Handy was given a friendlier, rounder design appropriate for his original purpose. I'm a fan of the classic Soviet-era aerospace aesthetic, so you'll see hints of Soyuz and Sputnik in a few designs as well.

The Protectron is an original design that went through many iterations before settling on something that does have the vintage character of Robby, and we think he captures the quintessential 1950's robot character more than any other. And the Sentrybot from the previous game looked a bit like a generic mech, so we took some liberties here and ended up with an imposing-looking tripod-mounted tank with guns for arms.

And Liberty Prime. Who doesn't like a friendly giant robot? We definitely had a bit of Iron Giant in mind when we pictured this guy, but Adam came up with an original, perfectly proportioned, towering robot that captured Liberty's Captain America personality. Then for the longest time we labored over how Liberty would launch his nuclear warheads. Railgun arms? Launcher mounted on a shoulder? None of these ideas seemed quite right until it occurred to us: Fat Boy nuclear warheads thrown like footballs. There are few moments in design where you know you've got it just right, but this was one of them.

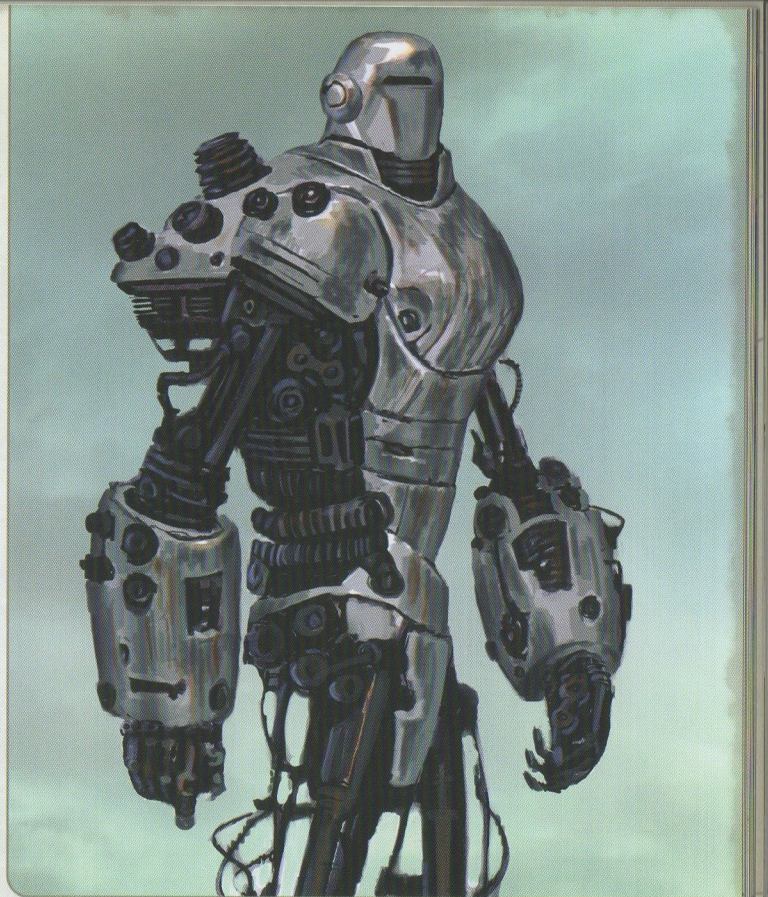

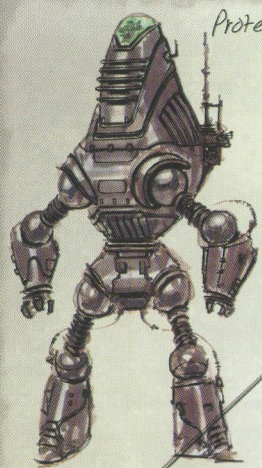

Protection

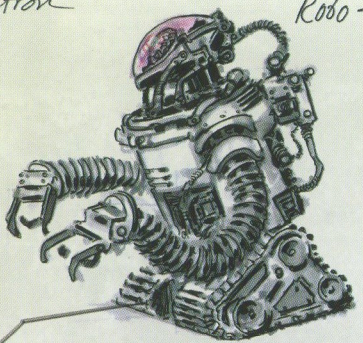

Robo-Brain

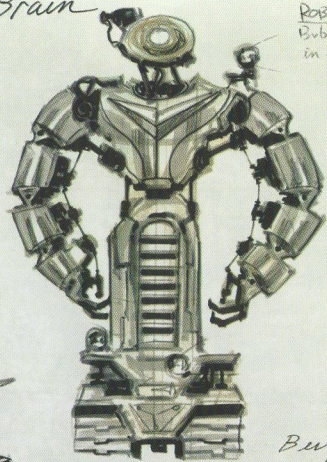

ROBO BRAIN:
Bubble effect
in JAR, please

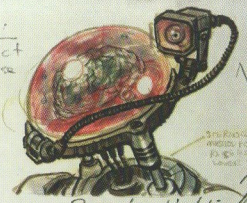

Single Unblinking
Eye!

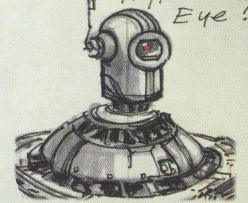

medical assistant

Bunker like
Head

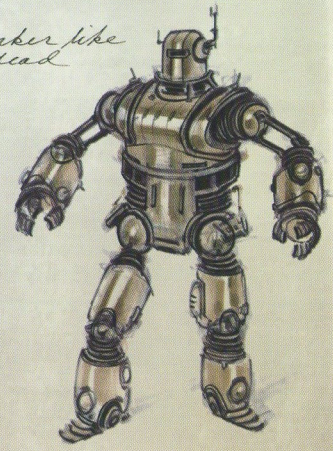
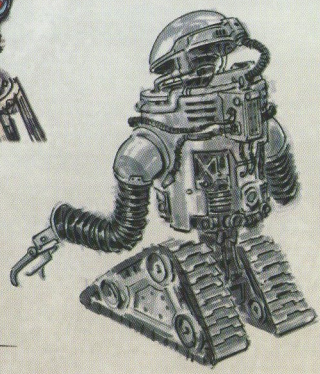
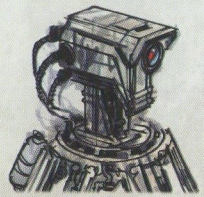
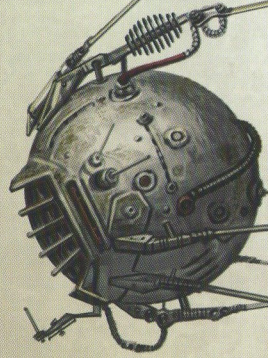

Flying Eyebot



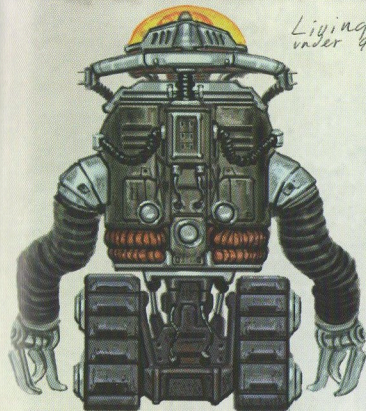

Living Brain
under glass

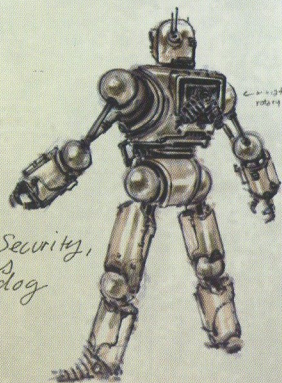
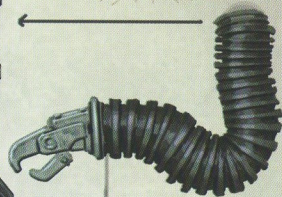
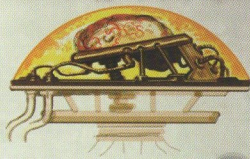
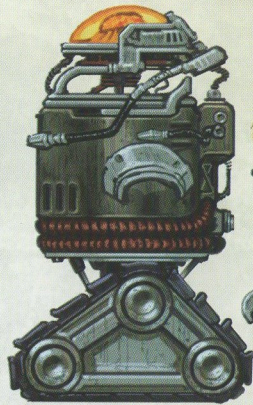
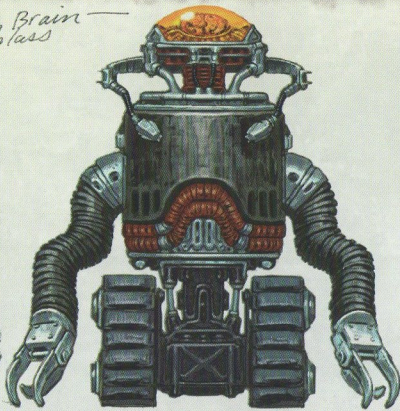

Home Security,
walks
dog

Rubberized Tread
groups
in oleum

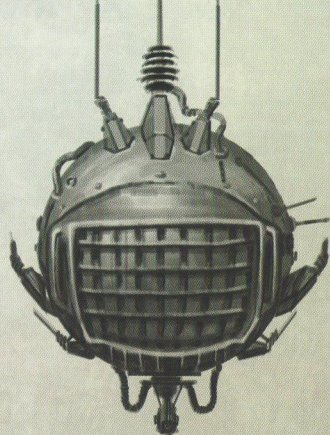
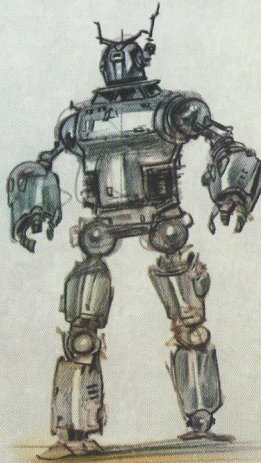
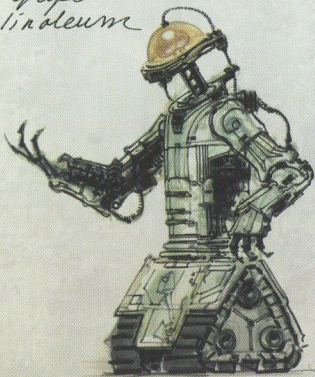

Protectron Iteration
43

broadcasts Enclave Radio



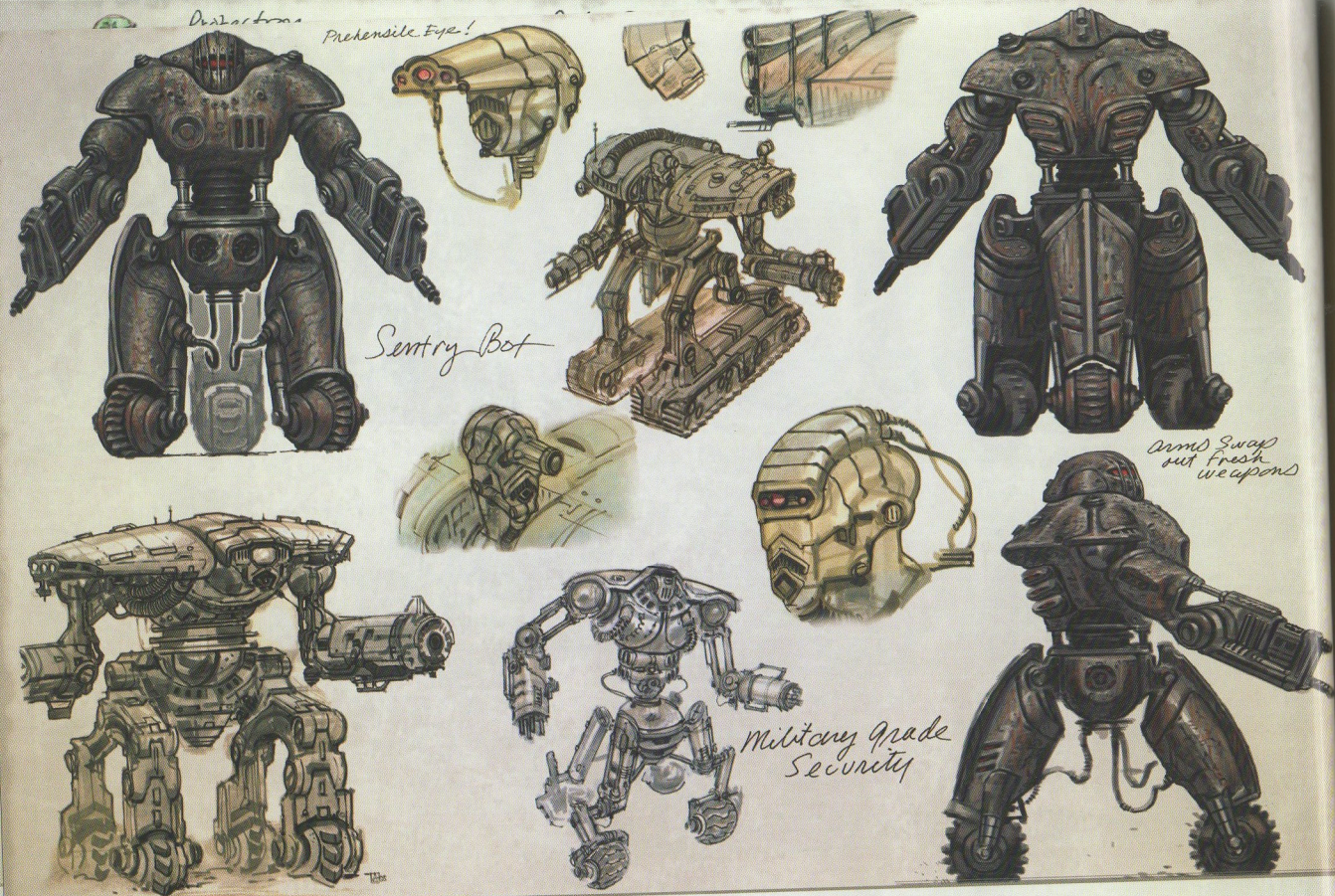

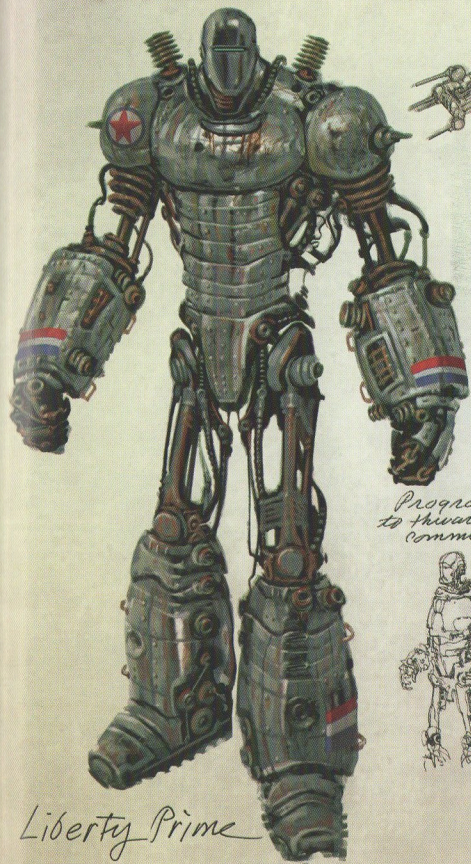

Liberty Prime

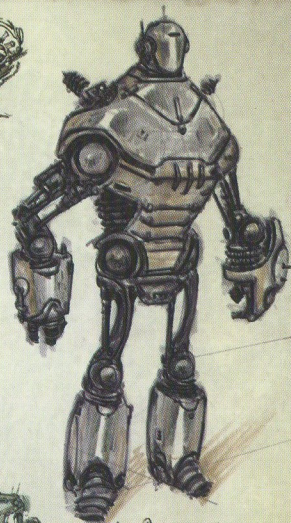
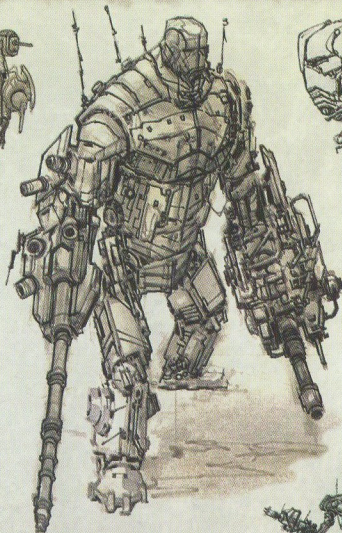
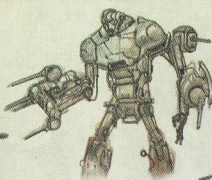

*Programmed
to thwart
communism.*

Liberty Prime Iterations

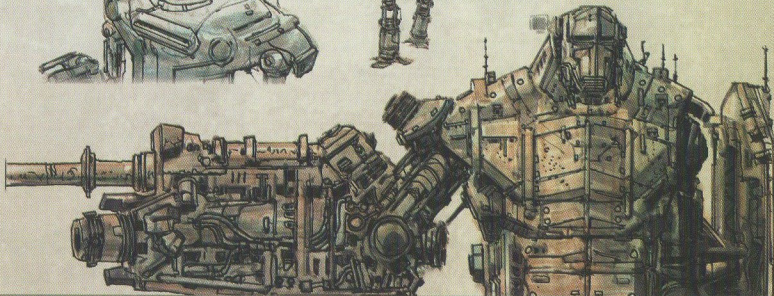
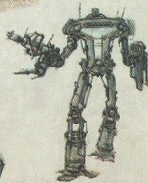
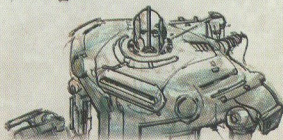

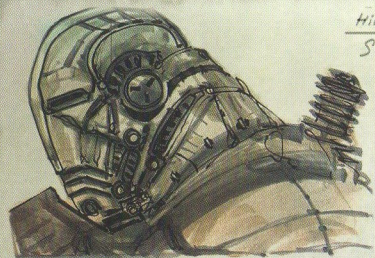

Hinged Poldron over
Socket

Twin Hoppers
Bomb Rack

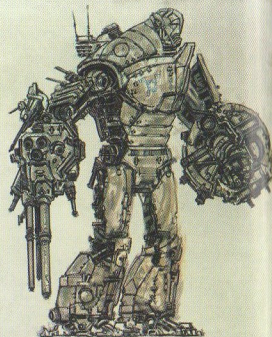
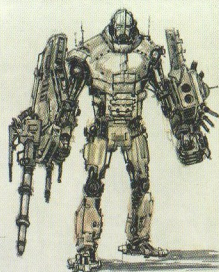

Heavy experimental Aeronautical
Intelligence, Prototype of Nasa, p. 33
lightning parts, venen, skeleton

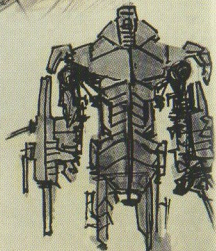
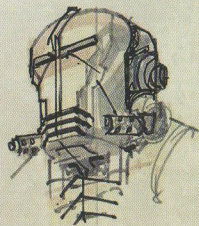
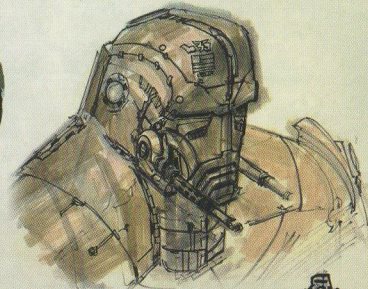
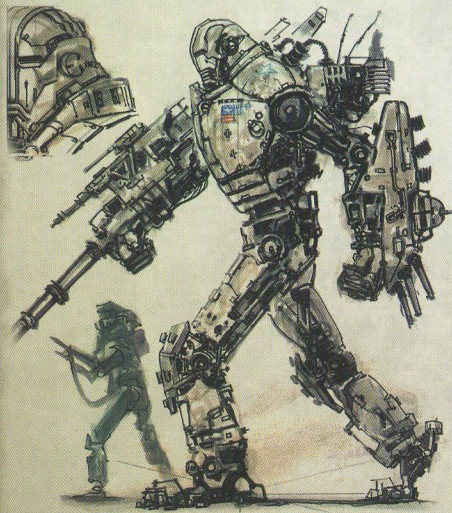
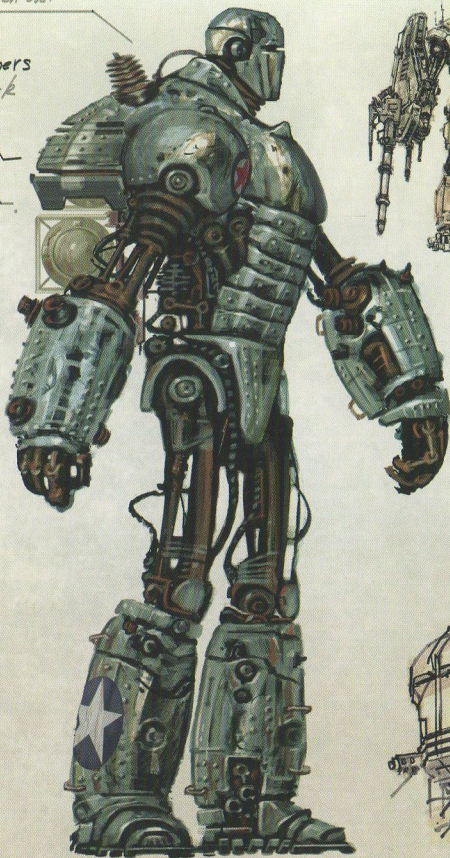

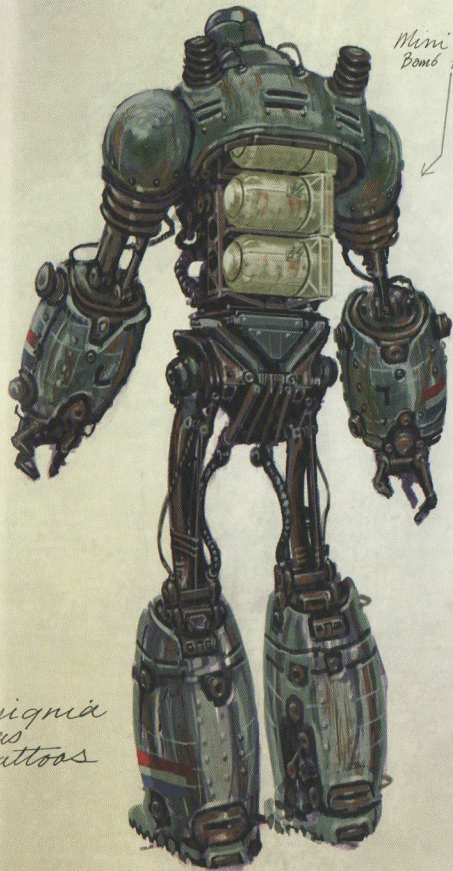

Mini Nuke
Bomb Bag

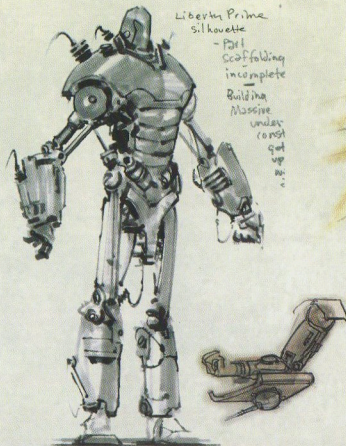

Liberty Prime
silhouette
- Full
scaffolding
incomplete
Building
Massive
under
construction
not up
yet

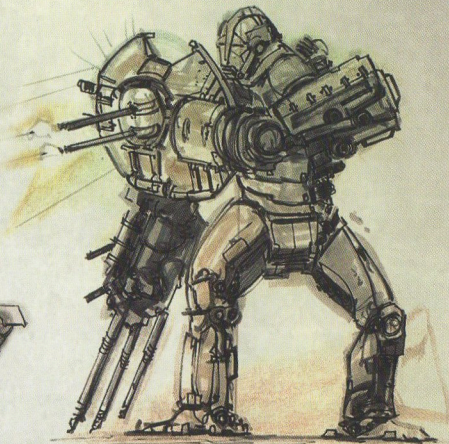

insignia
as
tattoos

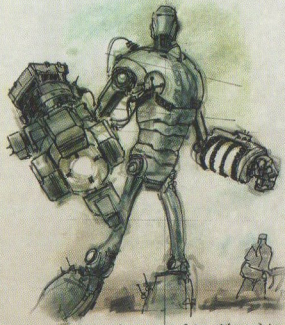

- GUN CHANNELS FORCE OF A SOUND (STRONG) IN
- ISS BOTH HANDS TO FIRE
- ARM (ONS INCREASE IN LIGHT INTENSITY
WHEN POWERING UP.
- ENERGY INCREASE ROTATES SPEED INCREASE
PUSH TO LAUNCHES or PENETS SPACE™

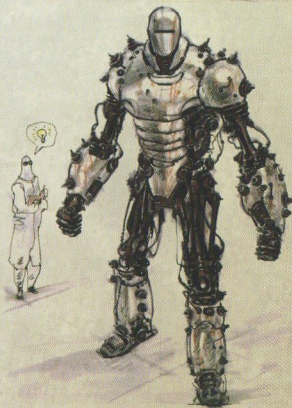

Squared heroic
features



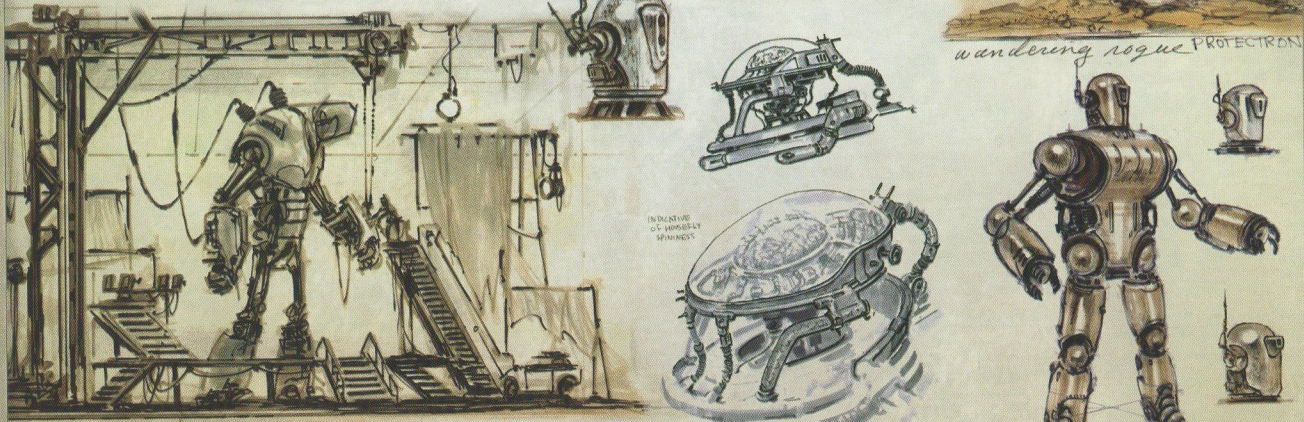
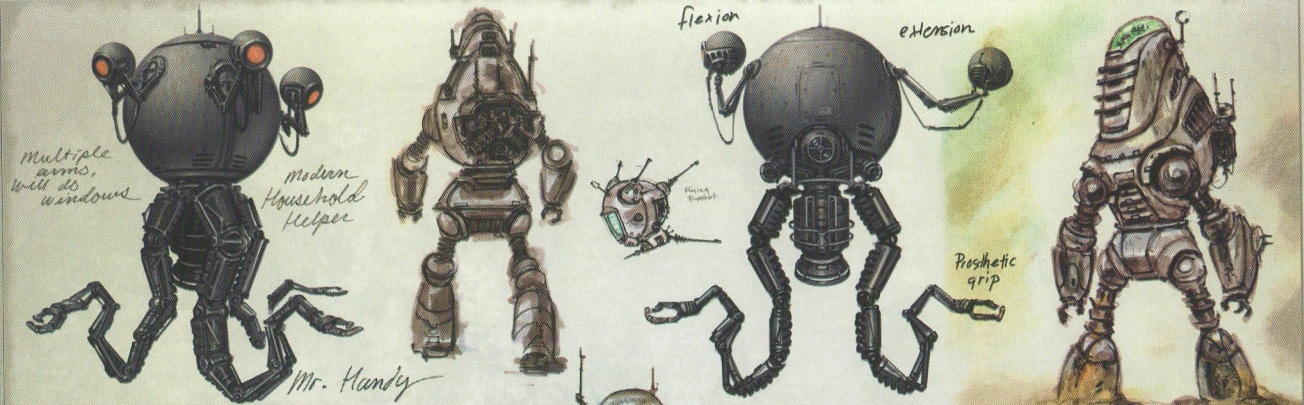

Liberty Prime Construction Bay



WEAPONS

It wasn't long into the project before I heard rumblings amongst producers cursing the number of playable weapons we had to build for this game. There are quite a few, and the amount of work that goes into getting a weapon built, animated, and programmed is substantial, comparable to the amount of development overhead a new creature model requires.

On the other hand, the effort was certainly worth it. The amount of variety in the weapons, both in terms of design and functionality, is very entertaining and makes the player's discovery of a new example a memorable experience. The design process for these varied greatly depending on the nature of the weapon. The more mundane designs, either real-world, or intended to feel like real-world, such as an assault rifle or shotgun, were designed by combining interesting elements from various existing guns into a new whole that felt slightly familiar but original at the same time.

When it came to the build-your-own and other exotic weapons, we went crazy. Physical plausibility may seem to take a backseat to some of these ideas, but the player must suspend belief and put himself in the mindset of a culture that imagined mini-nuclear reactors and ray guns as real possibilities in the near future. That being said, Adam was intent on making sure every weapon design, no matter how outlandish, looked authentic and mechanically sound.



Shishkesword

Crowbar hammered flat
Motorcycle Handle with brake
Flexible showerhead hose
Motorcycle tank

Surplus Pack Frame with seat belt straps
Oven Mitt Gauntlet duct tape reinforced

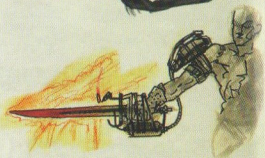
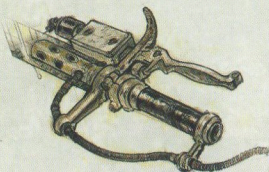
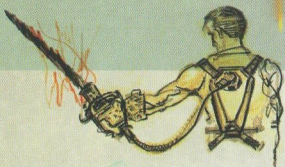

Subliminal Penetration
via HYPER HELMET



MEDICATRONS

HYPER HELMET™
Cerebro enhancement etc.

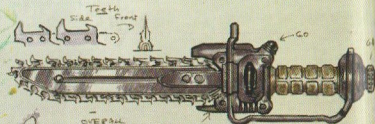

Teeth
Saw
Crack
GO
OVERALL
MORE MOTOR
MORE ON CROSS GUARD

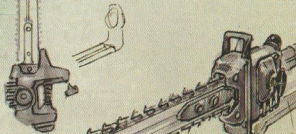
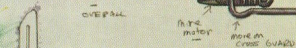

Pull
Round
etc.

Cerebro enhancement etc.



RAILSPIKE GUN:
Pressure cooker that
accelerates rail road
tie spikes...
at high speeds

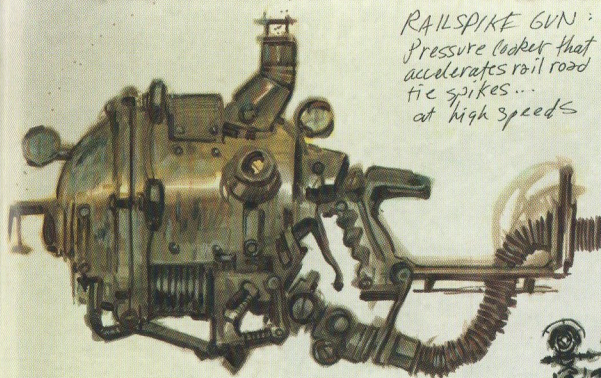

OLD TIME BOILER

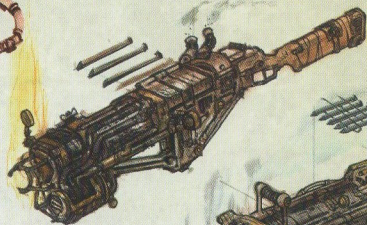
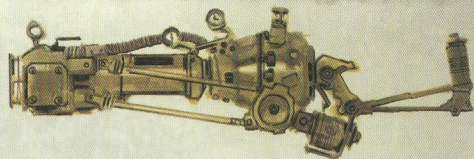
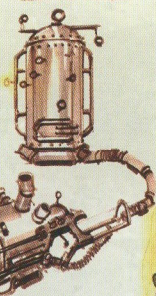

CARTRIDGES WIPPED BY MELT-SPRAYER WIRE

POOR CLUST DOWN

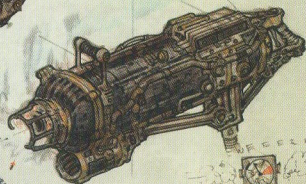

POOR CLUST

mesmetron

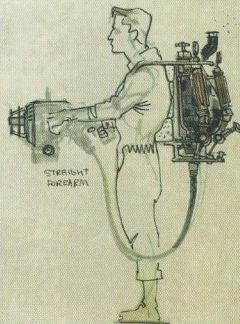
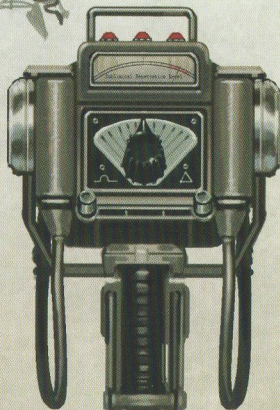
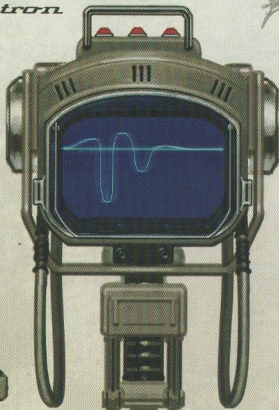
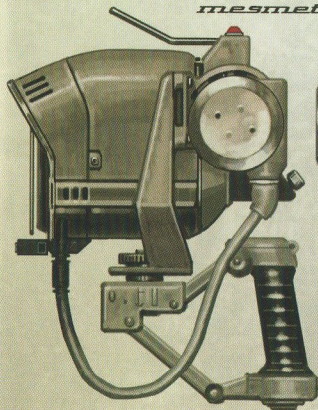

STRAIGHT
FORWARD



WEAPONS

55

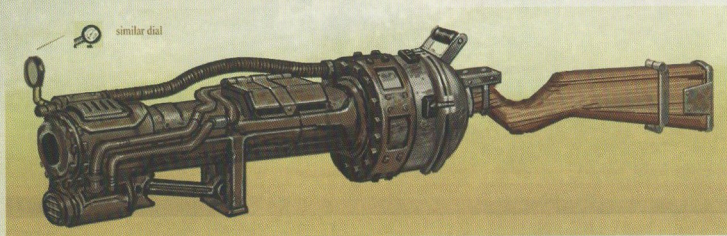
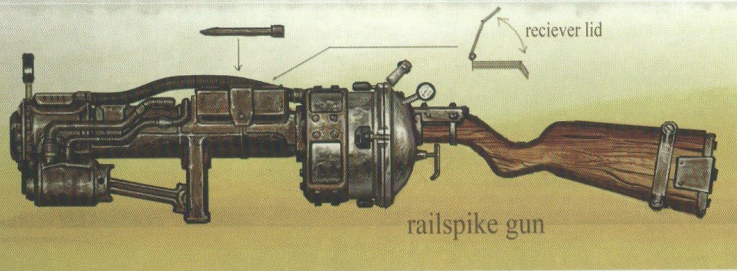

Sniper Rifle

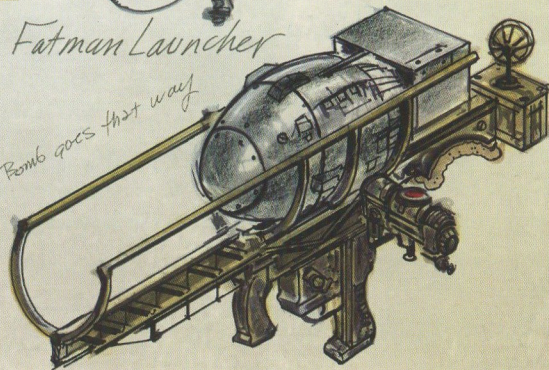
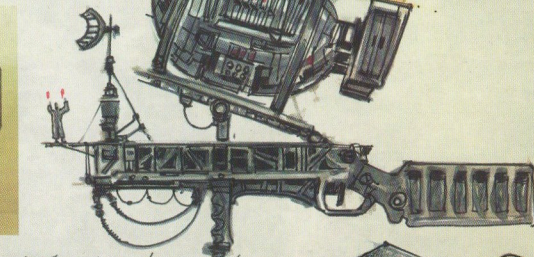
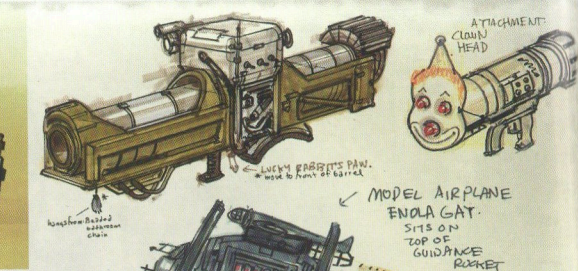
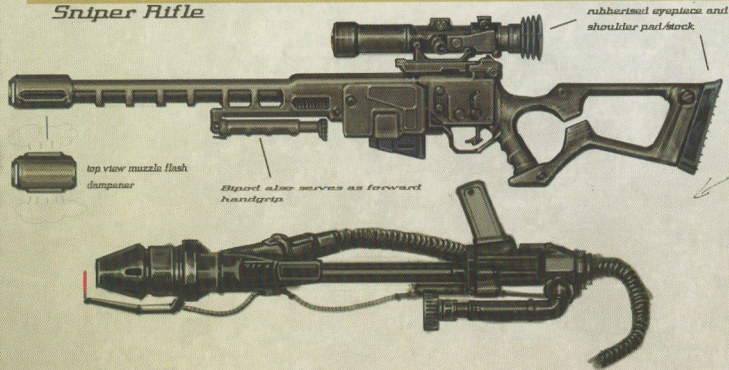

Handle position still being
tailored for animation

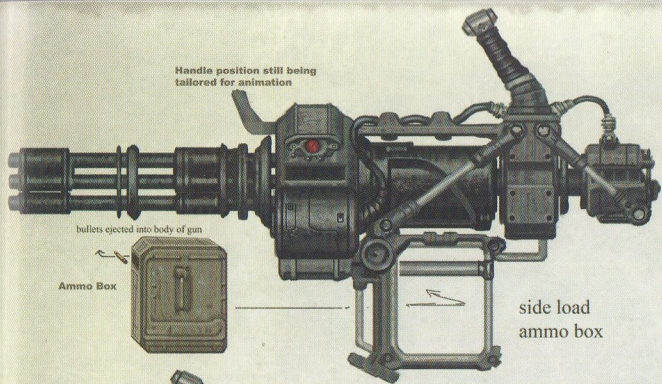

bullets ejected into body of gun

Ammo Box

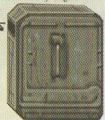

side load
ammo box

*Sub Machine-
gun*

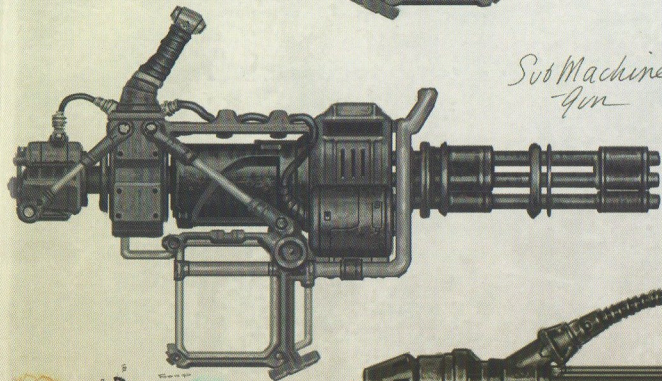

Flamer

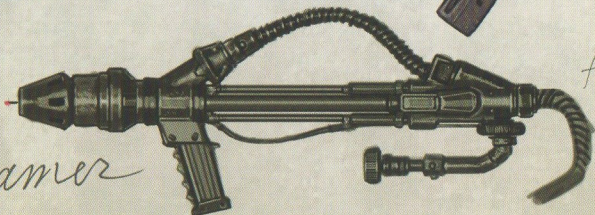

fuel

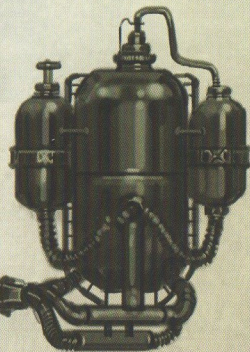

Double Barrel
Sawed
Off Shotgun
side view

*"Locked" trophy medal / w
gold "filling"*



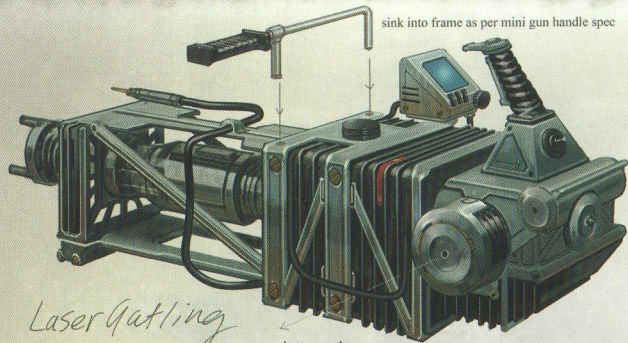

Laser Gatling

same battery as laser rifle

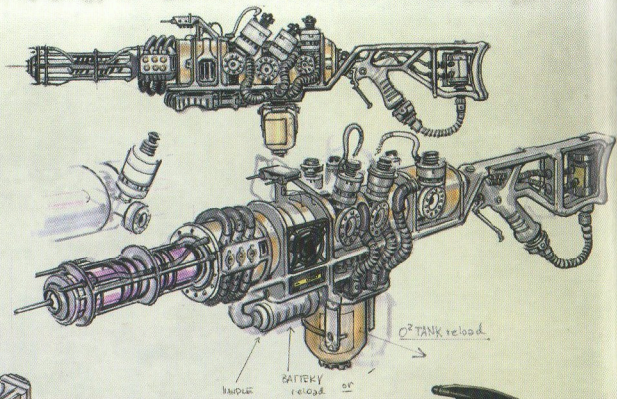

Plasma Rifle

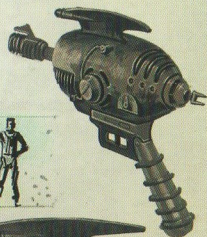
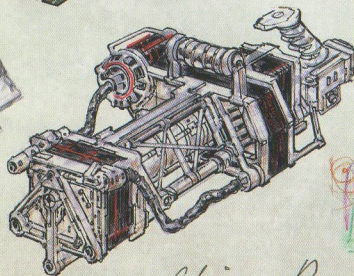
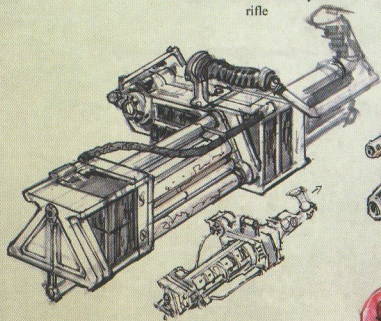

Alien Ray Gun

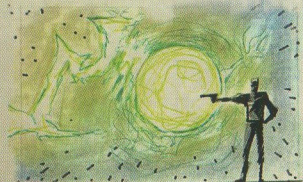

partial
energy
discharge
from
alien
space



oh my
gods!

SENSOR
WATCHER (SENSORS)
WATCHES
WHILE FIRING
WEAPON

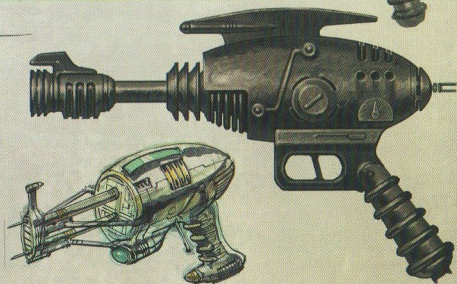
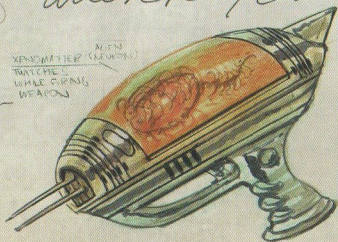

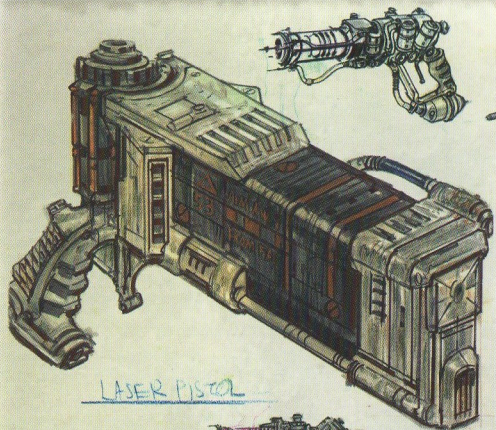

LASER PISTOL

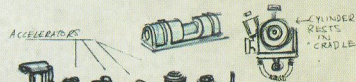
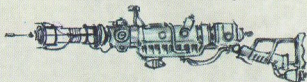
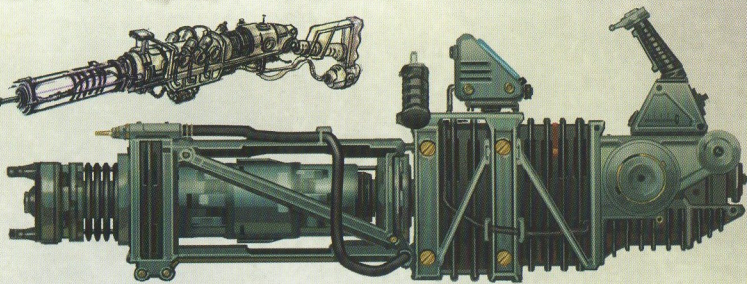
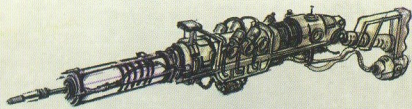
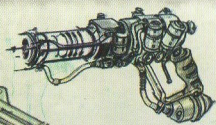

LASER RIFLE

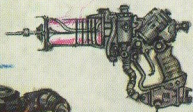

PLASMA RIFLE

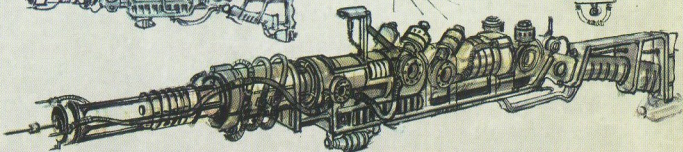

SOFT COIL

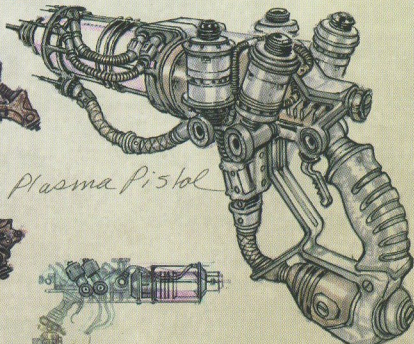
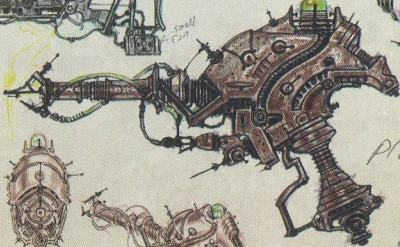

Plasma Pistol

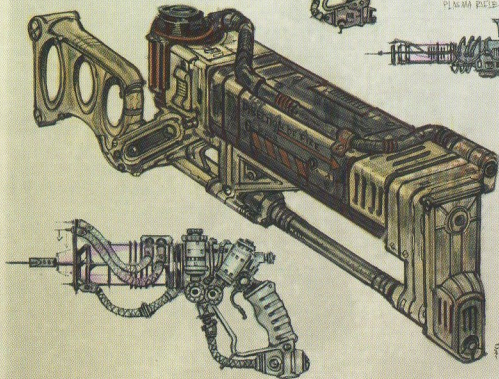

HUMAN HANDS COMPRESSION 2012

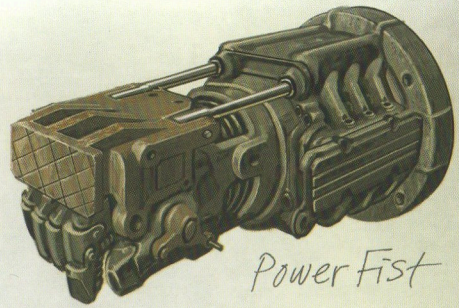
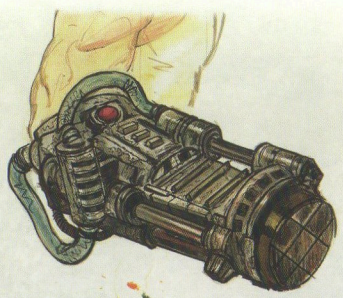

Power Fist

DEATHRAY CHAINLET -
Surface Weather - hot
unstable...

DEATHRAY - 10-12"
- 2X C PROBE
on signal -
- paralysis,
- 1, 2, 3, 4, 5, 6, 7, 8, 9, 10, 11, 12, 13, 14, 15, 16, 17, 18, 19, 20, 21, 22, 23, 24, 25, 26, 27, 28, 29, 30, 31, 32, 33, 34, 35, 36, 37, 38, 39, 40, 41, 42, 43, 44, 45, 46, 47, 48, 49, 50, 51, 52, 53, 54, 55, 56, 57, 58, 59, 60, 61, 62, 63, 64, 65, 66, 67, 68, 69, 70, 71, 72, 73, 74, 75, 76, 77, 78, 79, 80, 81, 82, 83, 84, 85, 86, 87, 88, 89, 90, 91, 92, 93, 94, 95, 96, 97, 98, 99, 100

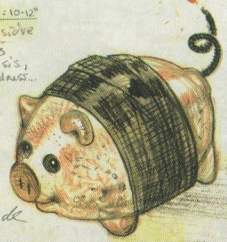
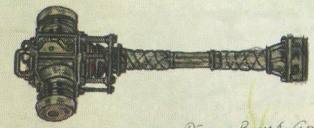

Piggy Bank Grenade

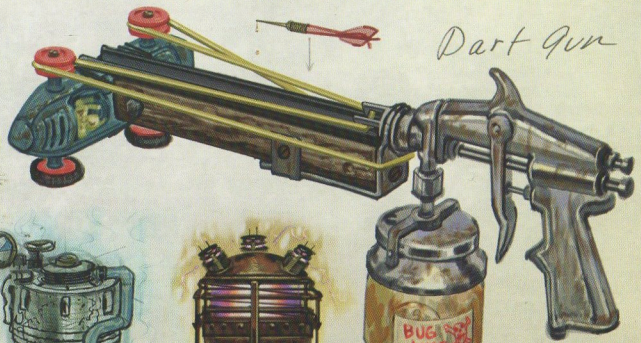

Dart Gun

Mason Jar Mine



EMO (ElectroMagnetic Pulse) Grenade

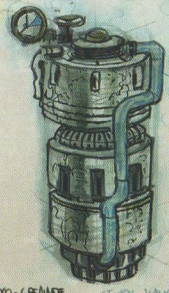
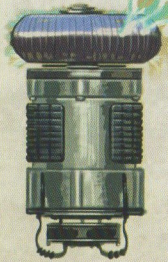

Plasma Grenade

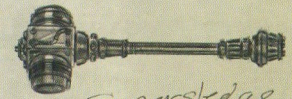

SuperSledge

BOTTLE CAPS / NAILS

RYO-GRENADE - TYP VALVE ACTIVATE AIR FLOW



HARDWARE

Inspiration for much of the various bits of technology in *Fallout 3* came from both commercial product design and military industrial design of the 1950's to early 1960's. Elements from items such as old portable television sets and army field radios were studied and incorporated in some fashion along the way. We often try to achieve a careful balance of realism, future-retro-style, and practicality in the objects that people would interact with in the world. In terms of realism, it's not an essential factor, but a sense of believability within the rules as defined in the *Fallout* universe is important.

Technology in the world of *Fallout 3* is somewhat paradoxical in that it's incredibly advanced in some ways, and downright primitive in others. Certain technological advancements that we take for granted in our own history either did not occur, or developed along a very different path. One element that has advanced to an incredible degree is the use of miniature fission reactors in a variety of applications. Inspired by the futuristic 1957 Ford Nucleon concept car, the idea of everyday vehicles powered by a micro nuclear reactor in the trunk is fully realized in the *Fallout* universe. Of course, hundreds of years after the war the country is full of automobiles with unstable reactors that are way overdue for service and replacement, but this makes for the entertaining blowing-up of what would otherwise be unremarkable background art.

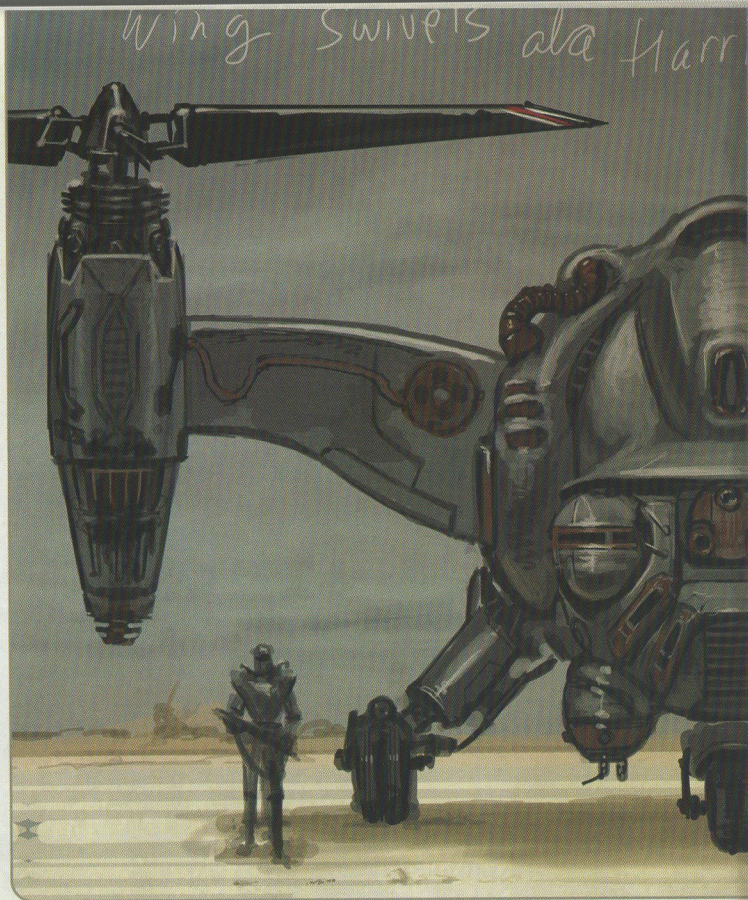

Vertibird

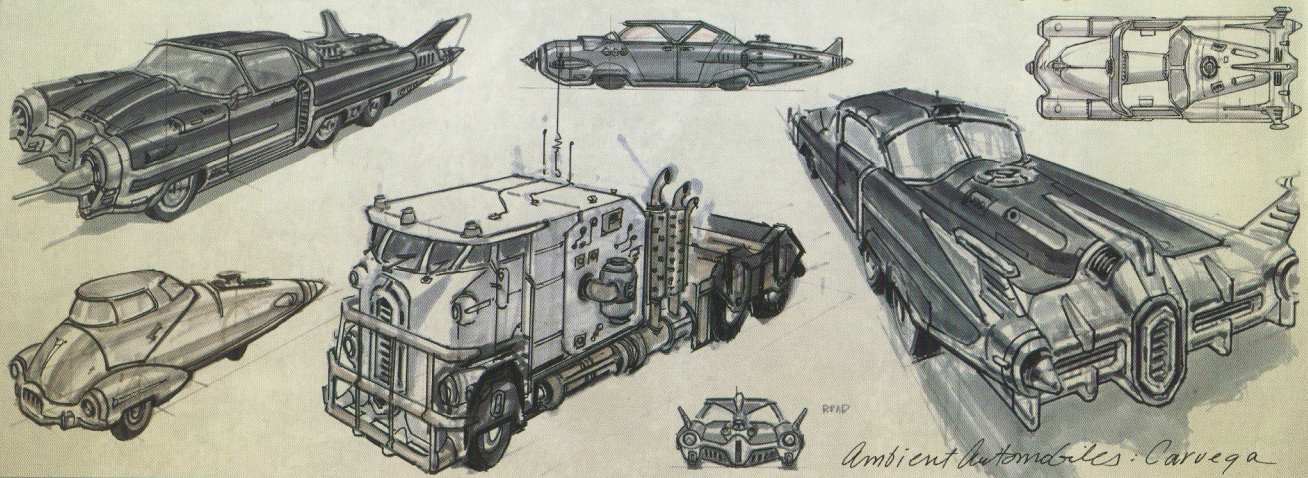
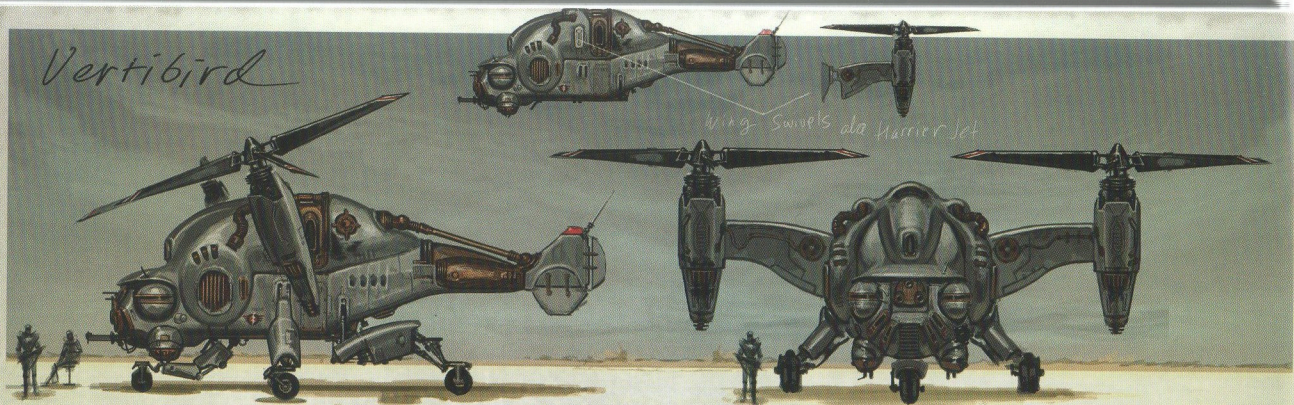

Ambient Automobiles: Carvega



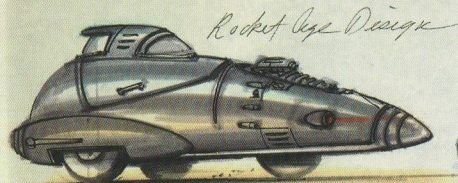
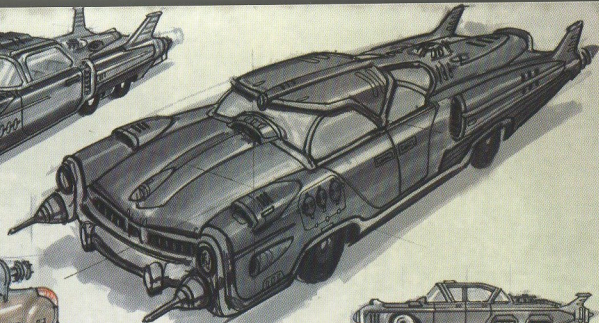
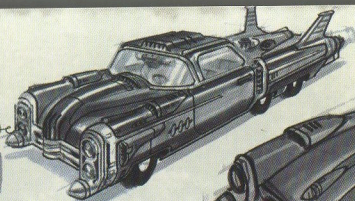
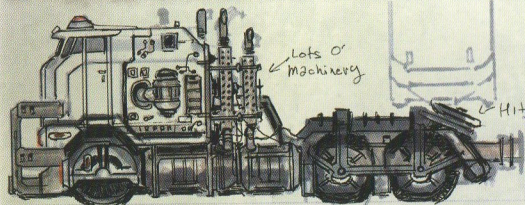

Rocket Age Design

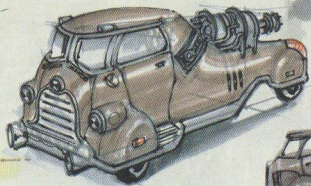

TEARDROP



3 Wheeler "Flea"

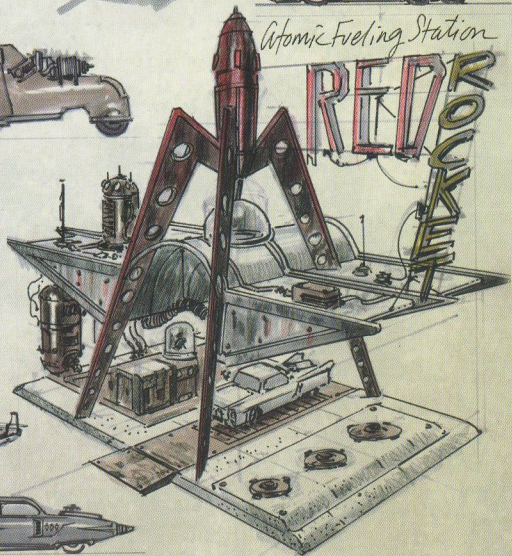
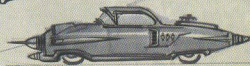
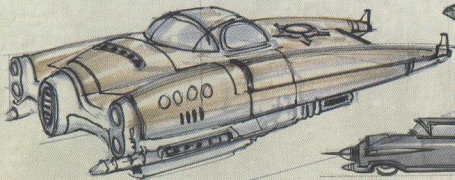
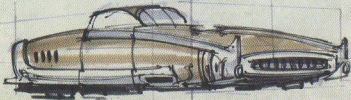
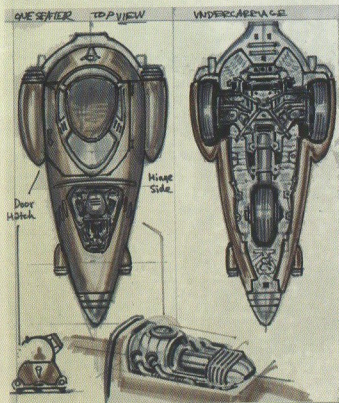

Atomic Fueling Station



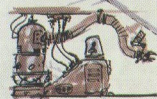
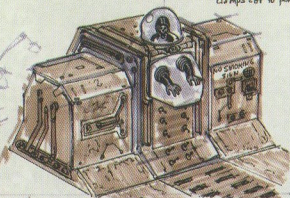
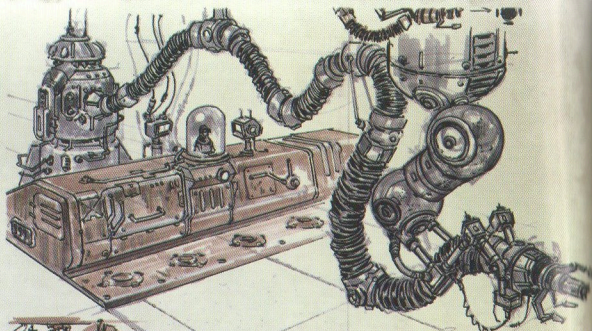
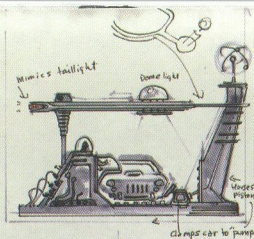
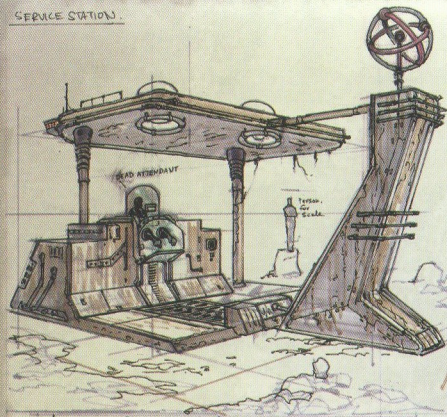

← machinery → ← garage of →

RED ROCKET

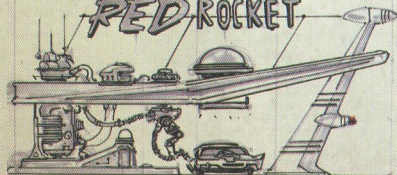

Highway Pillar (Bridge Overpass)

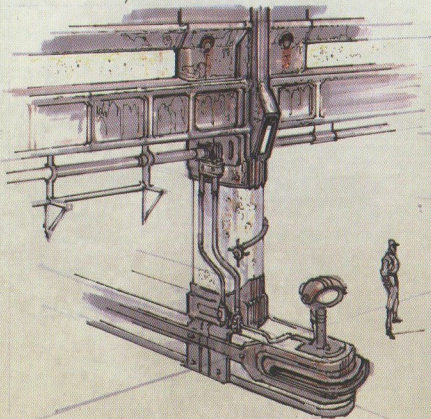

Bus Shelter

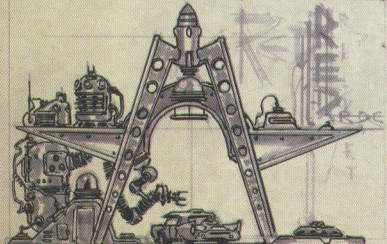
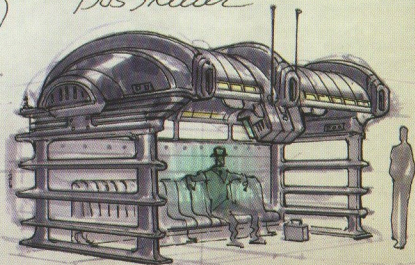

STREET HARDWARE = EXCESSIVE SUB. GAS & BTX

BUS SHELTER W/ BUILT IN EXTENSION

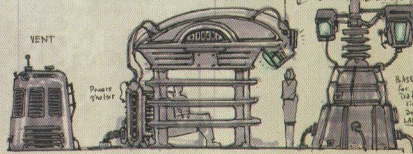

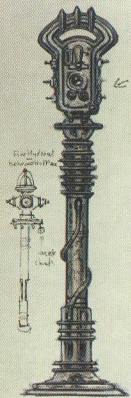

Potential
Mace
for
Super
mutant

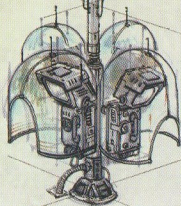
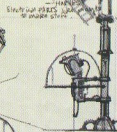

Phone Kiosk

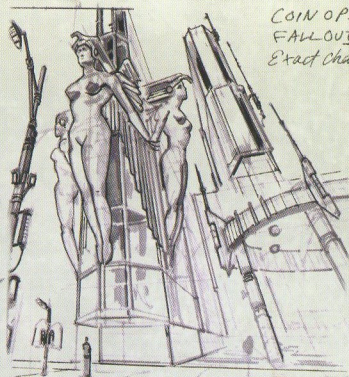
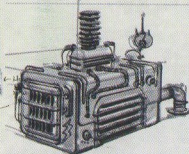

COIN OPERATED
FALLOUT SHELTER
Exact Change Only!

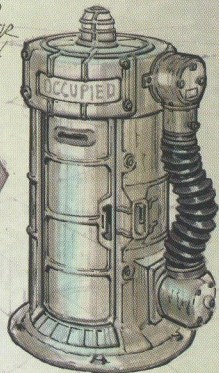

STREET CLEANER

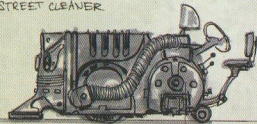

Cornice Shield

attractive bomb protection
in stainless steel also
houses conduits
for lightening,
AV equipment

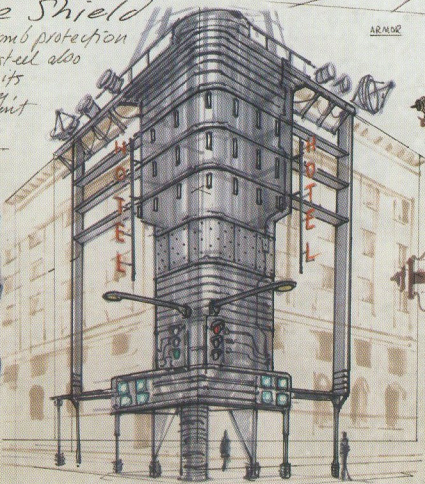

ARMOR

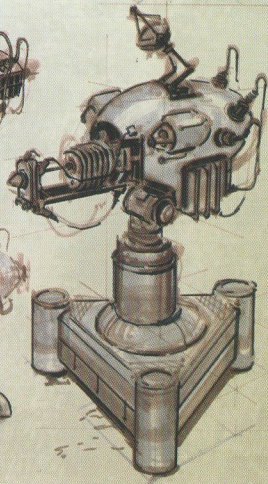
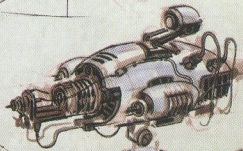

Street Cleaner

PORTABLE
MANUAL
STREET
VACUUM
TURNED
INTO
WEAPON...
*Humble Origin of
The Rocket Launcher!

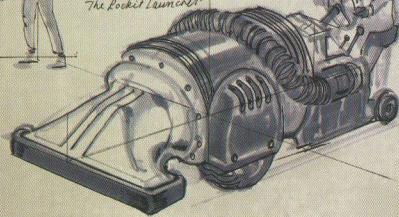



Microfilm Reader

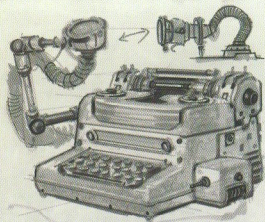
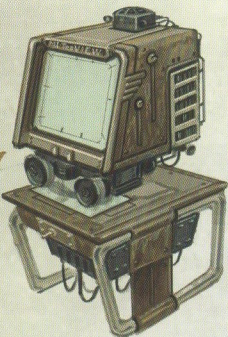

PROTECTION POD - 6
STACKABLE for 50-100mm

Protection Storage Pod

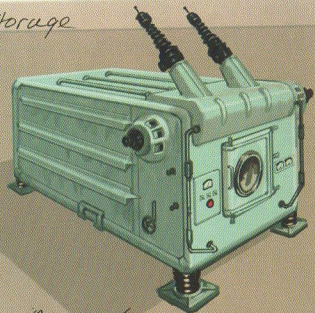
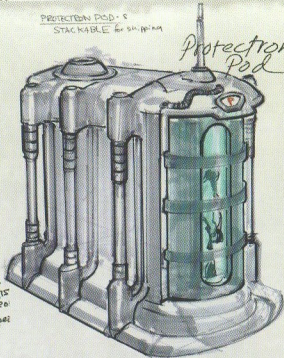

Recycler

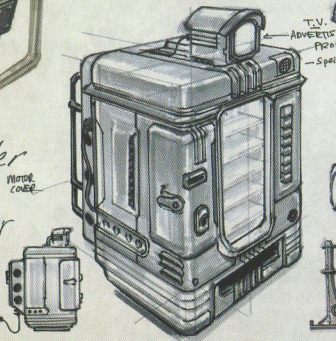

MOVIE CASE

TV ADVERTIS-
MENT
POPE
-SPOT

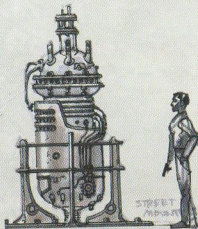

STREET
MUSIC

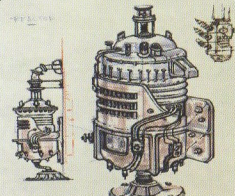
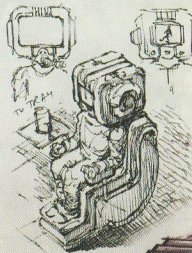

SURVIVE ELEMENTS



Ditch
keyboard
→
Logos

Force Field Generator

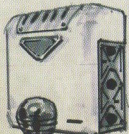
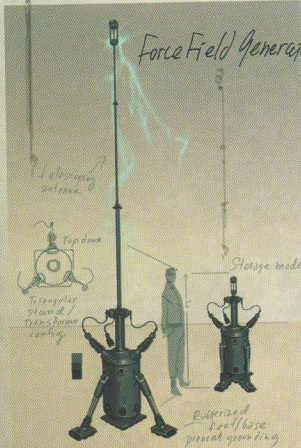

Hand Dryers



NOVA COLA VENDING MACHINE w/ BUILT IN TV for Ad.

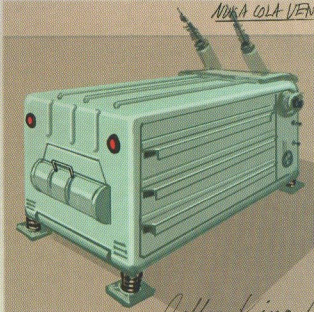

Coffee King!

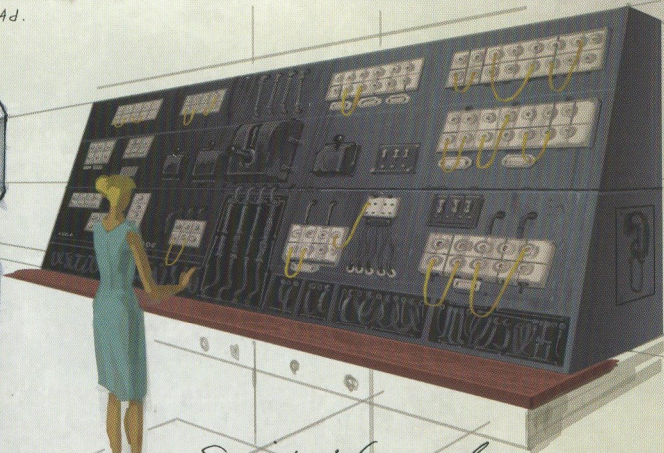
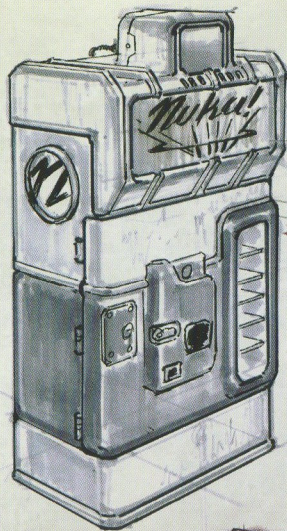

Switchboard

Computer Monitor/
Terminals

"Cuz King Coffee rules
this fine morning!"
- annoying Ad

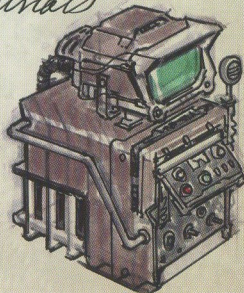
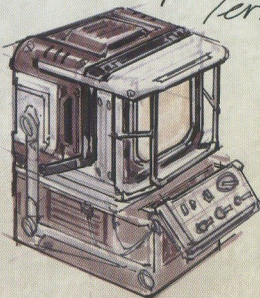
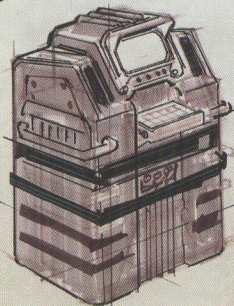
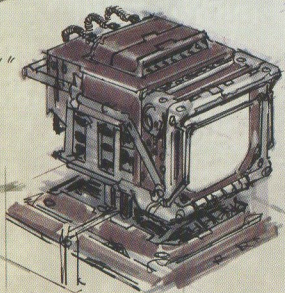

Tranquility Lane T.V. Land Lounger

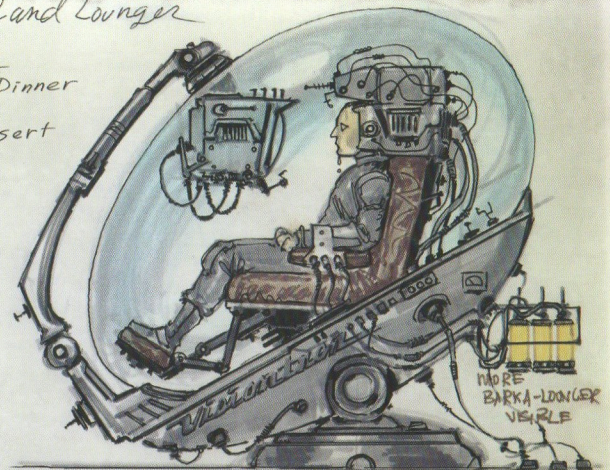
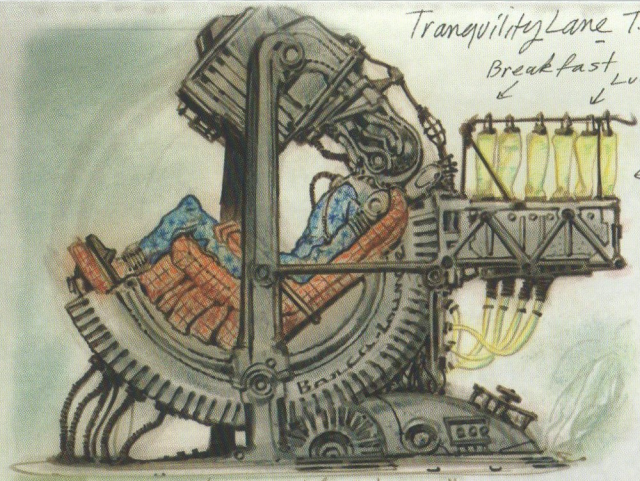

"It's just like a space helmet Jimmy" ^{Director}

Shower Stall/Modular Vault

Tranq Lane Headset/Pod

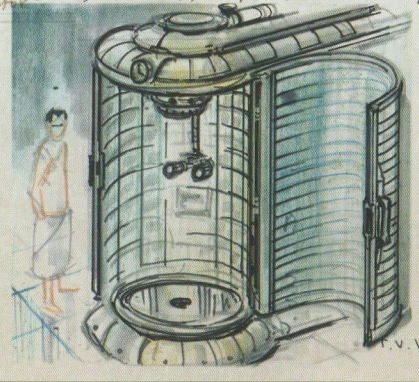
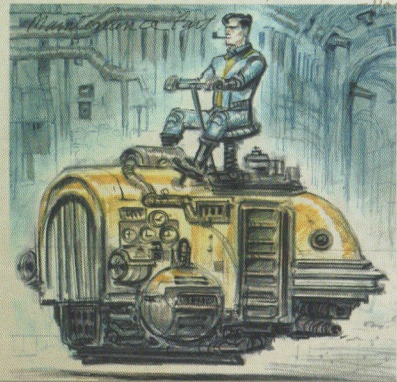

T.V. Womb



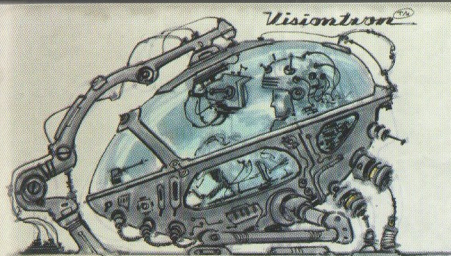

Visiontron™

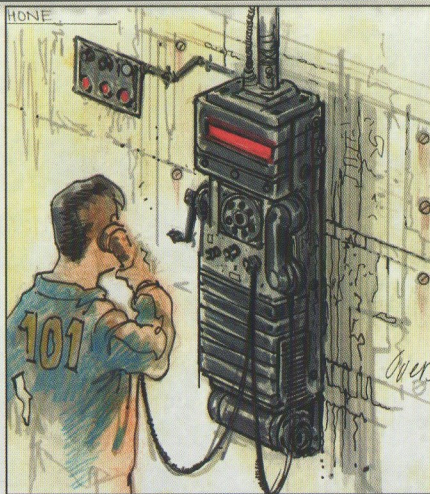

TELEPHONE:

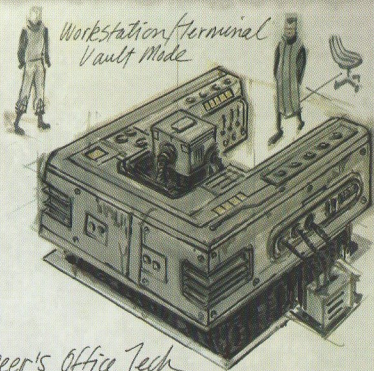

Overseer's Office Tech

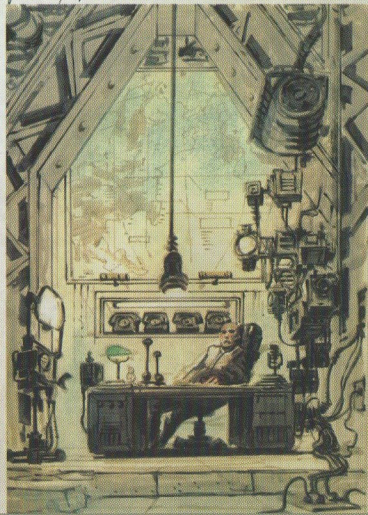
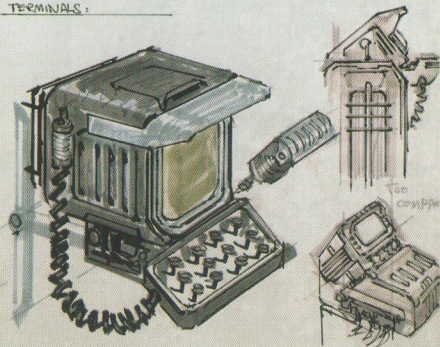
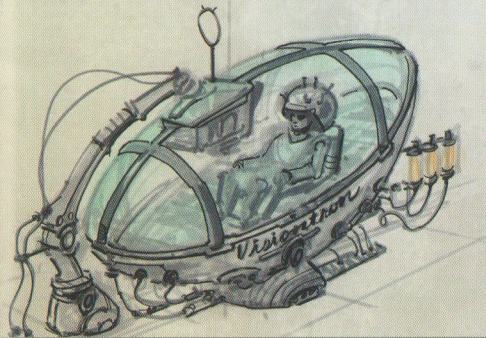
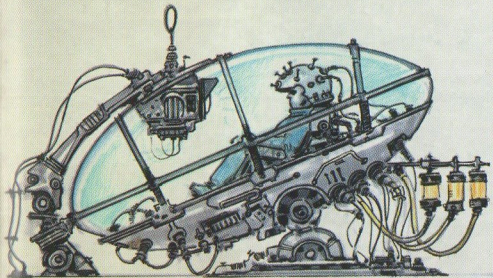

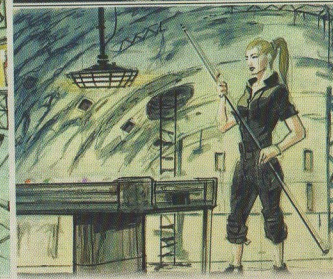
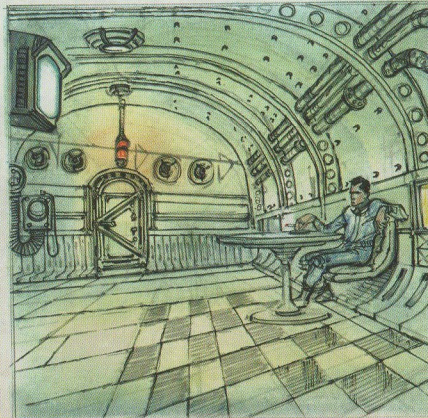
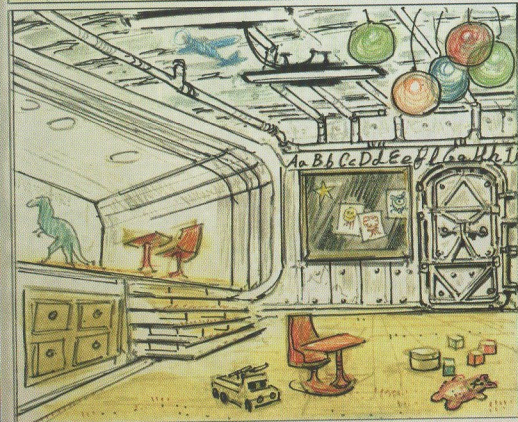
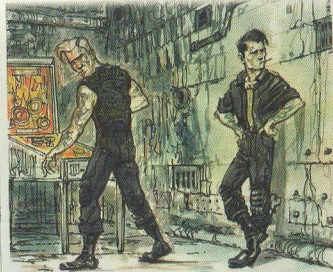
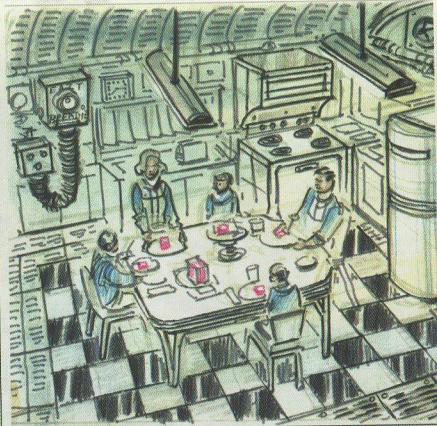

THE WORLD

This section covers *Fallout*'s various environments and locations, and the many structures that appear throughout. Although it takes a good deal of trekking through the world to see it all, there's quite a bit of variety in the environments. At one extreme we have the classic post-apocalyptic rusty, ramshackle town (but with a twist) in Megaton. And at the other are the vaguely Orwellian, massive steel and concrete government buildings in downtown D.C., or at least what's left of them. There's a decent variety in architectural styles, a blend of Googie from the 50's and 60's with some 40's-era art deco thrown-in for good measure. And to ground it all with a strong sense of past-as-we-know-it, the neoclassic buildings that pervade the heart of the Capital are ever present.

Given the scale of the game world and limited resources, we have to resort to building limited sets of buildings of different classes, which we then mix about when building-out the game's locations. You'll see here a variety of these structures, some of which appear in game, but by no means a comprehensive list. Architecture is something that although we do plenty of designs for, often it's left to the mesh-builder to work-out the exact implementation as needed.

There's a selection of interior environments consisting of standard dungeon types, such as the metro system (pictured here) and abandoned Vaults, as well as the cluttered homes of surface dwellers. All of these areas are a combination of the past, hints at the culture and society before the war, with a layer of years of decay and grime, and a final topping of the current struggles of desperate survivors trying to make a home for themselves, be they human or not.



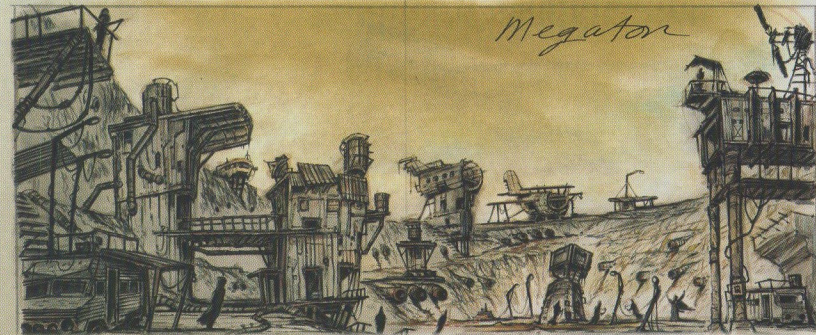
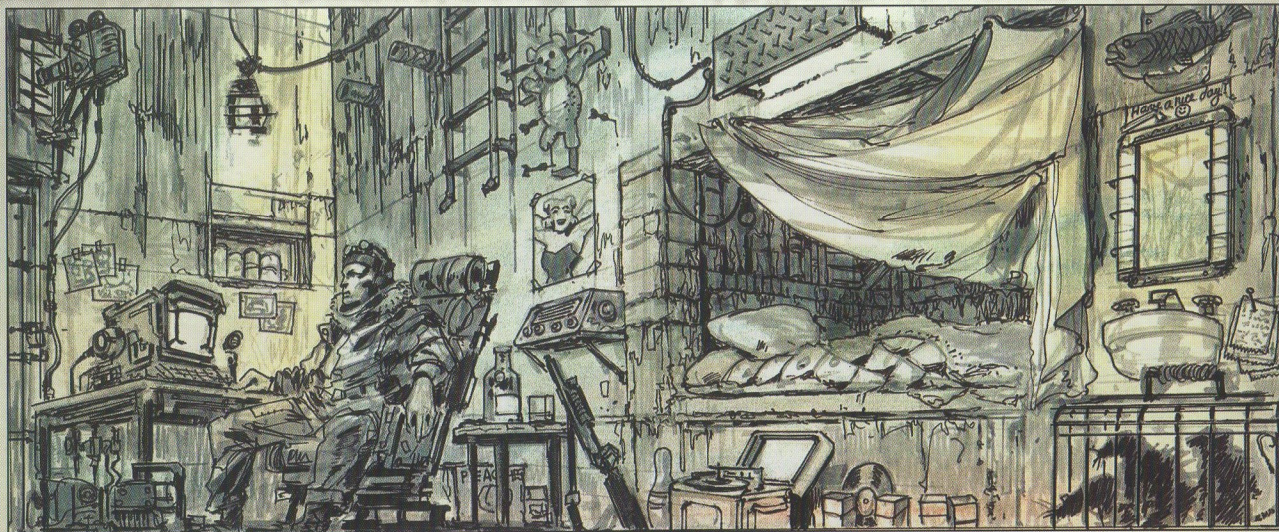

Megaton

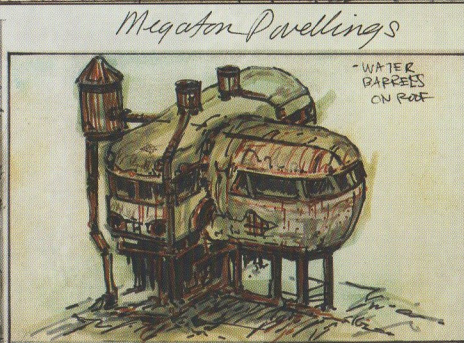

Megaton Dwellings

- WATER
DABBERS
ON ROOF



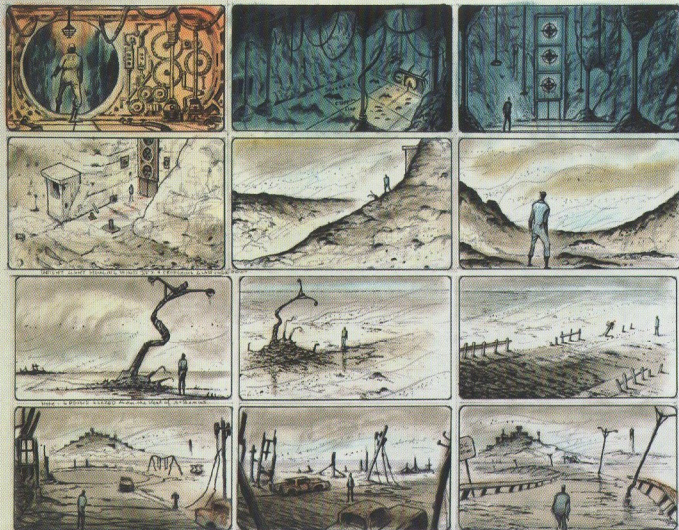

ESCAPING TO THE SURFACE

MEGATON BUILDINGS TIME

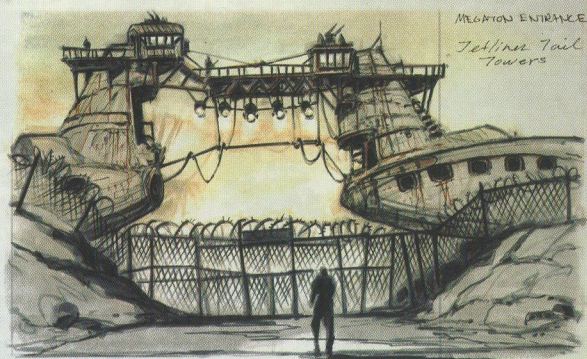
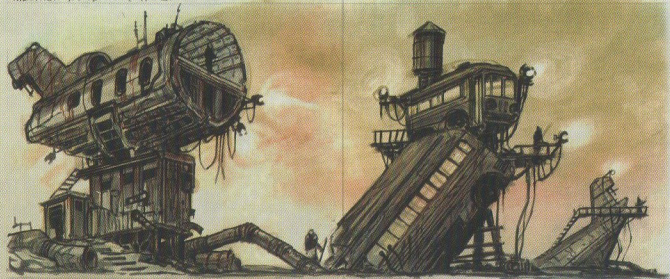

MEGATON ENTRANCE
Tailored Tail
Towers



Megaton Crater



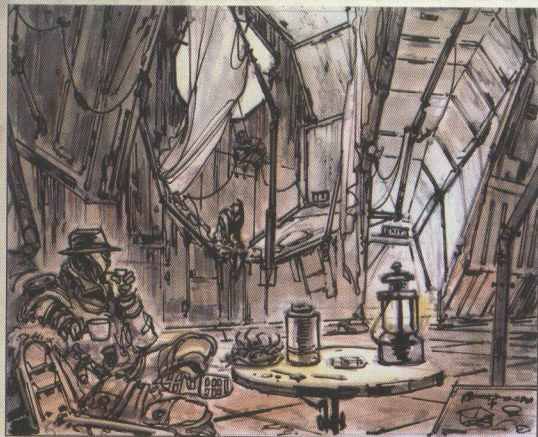

Regator Interior Space

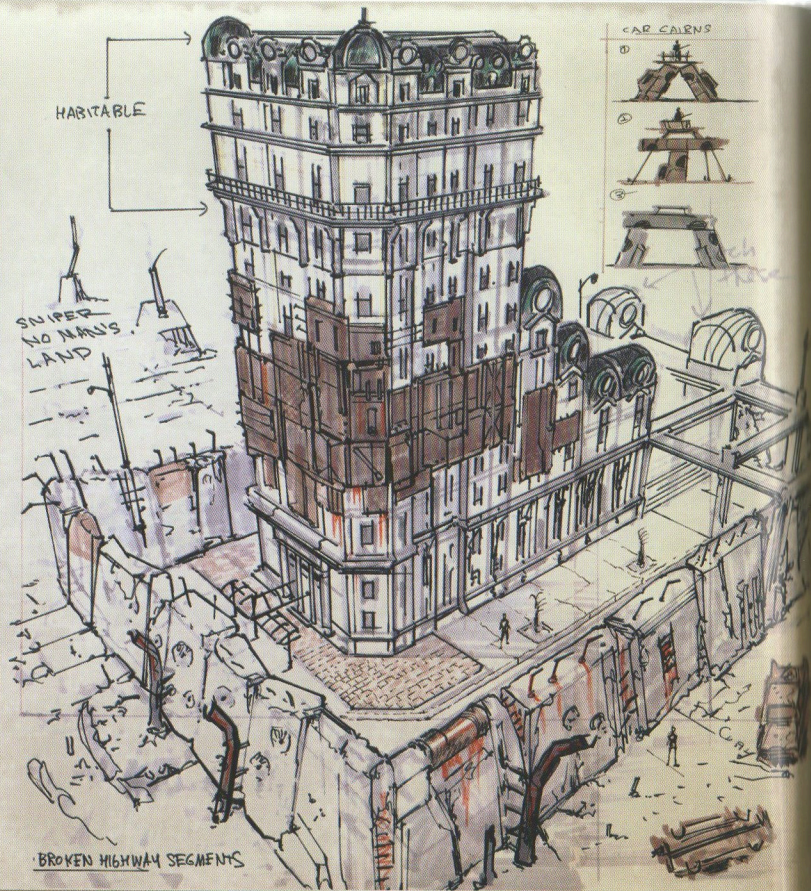
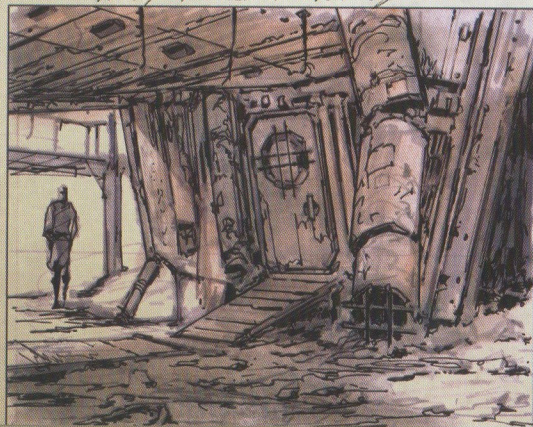

Tenpenny Tower

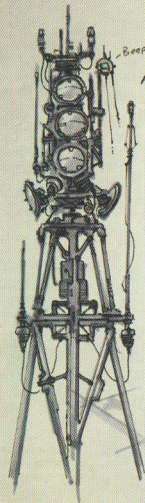

Radio Tower

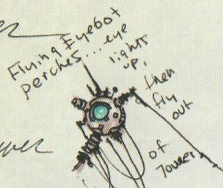

Flying Eyebot
perches...eye
lights up...
then fly out
of tower

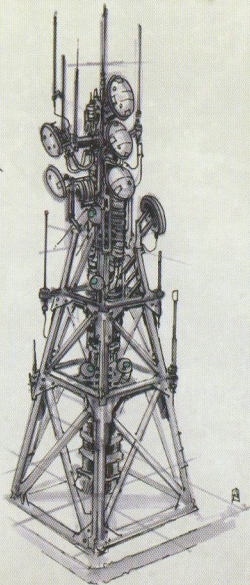

Moscow's
Bun →

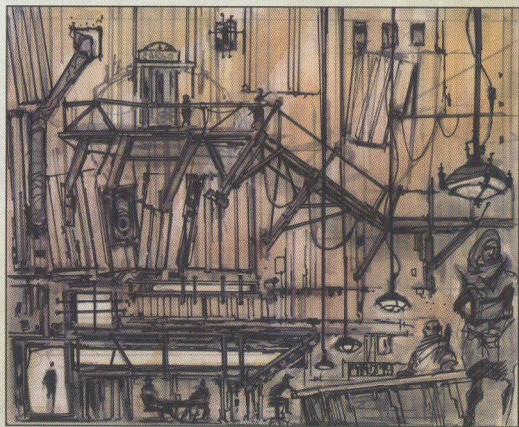
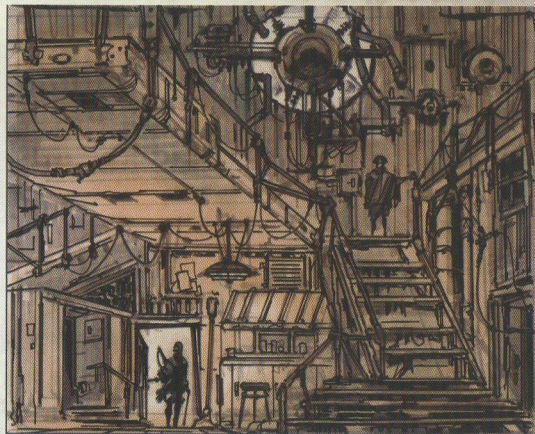
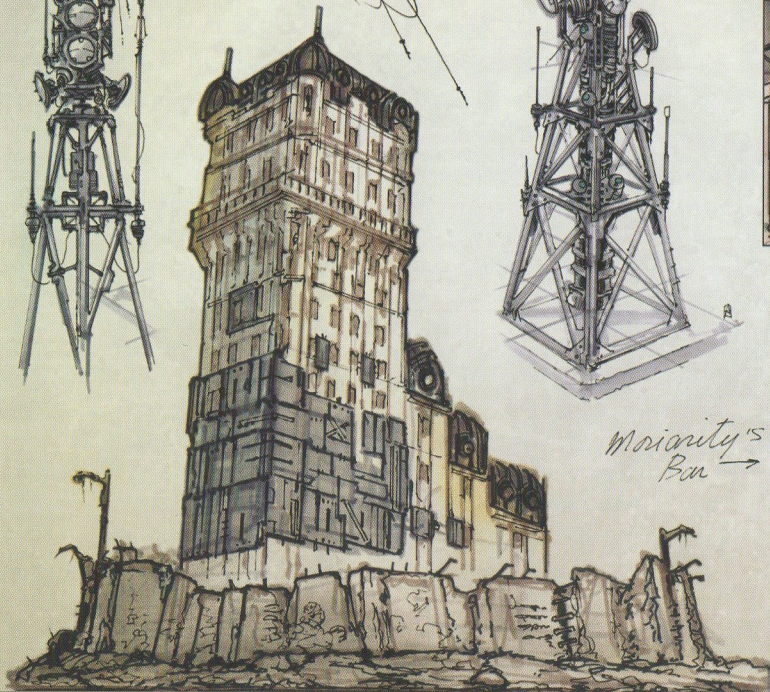

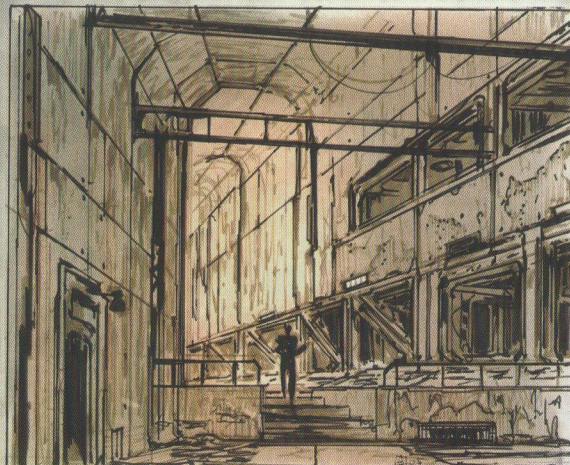

Paradise Falls Layout

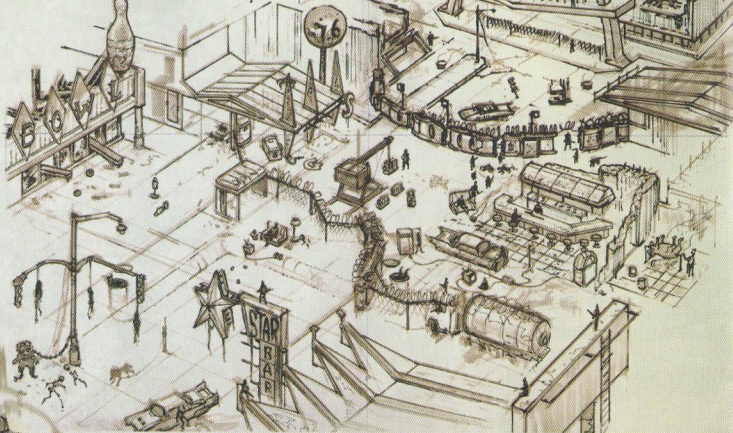

The Citadel





COURTYARD: TRAINING
SQUARE ETC.

ENTER PLATE:
REINFORCED ROOFTOP

Citadel Gate

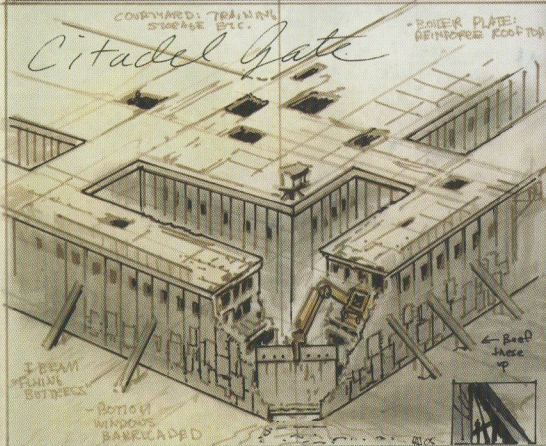

I BEAM
FINAL
BETWEEN

- BOTTOM
WINDOWS
BARRICADED

← Beed
Jesse
UP

ARCHITECTURAL
NOTE: FALLEN

PILES OF LETTERS (BIG)
UNDER DESTROYED
MARQUEES ...



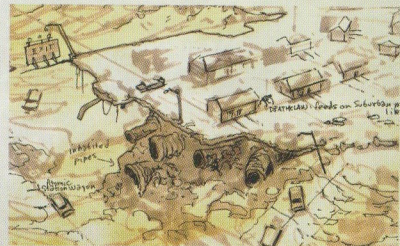

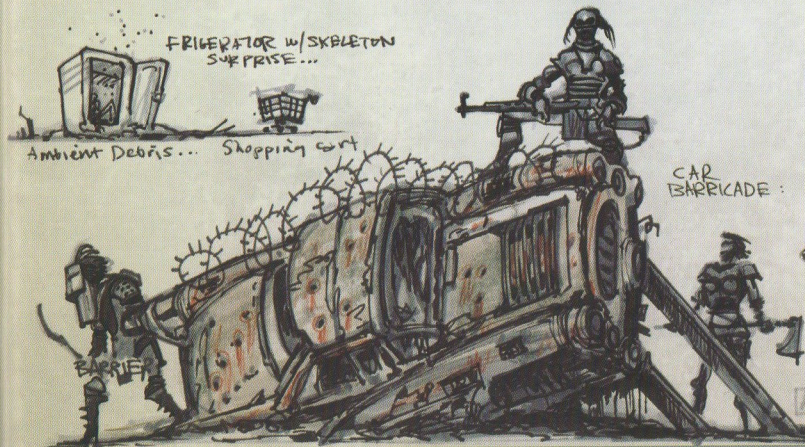
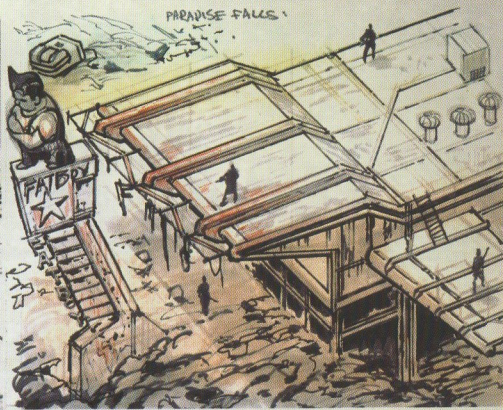
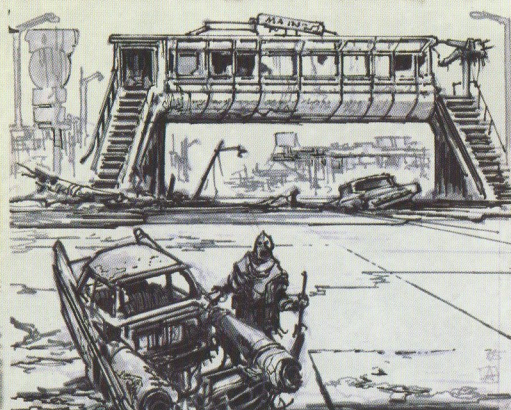

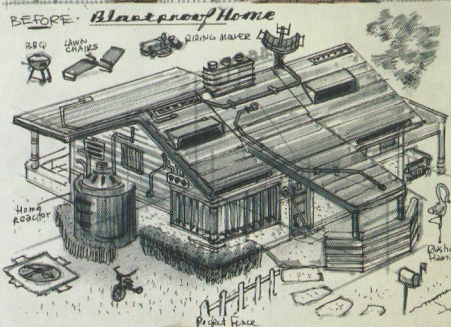
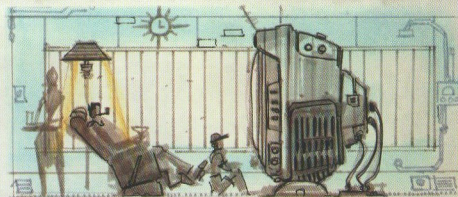
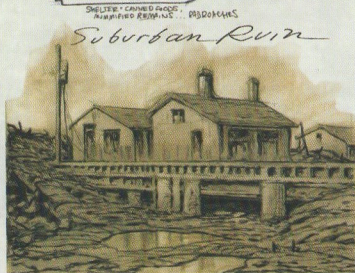
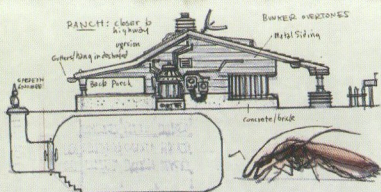

Aircraft Nose Hut

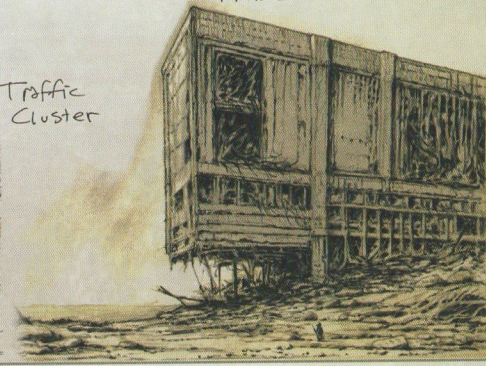
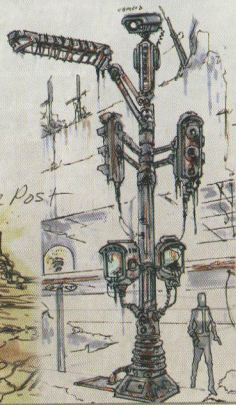
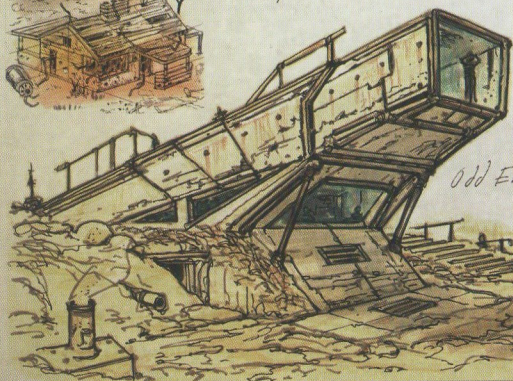

CLINIC
 - FAST TO MASH TENT... SNAP
 - PORTABLE - FITS IN ANY SETTING... RECOGNIZABLE FROM A DISTANCE...
 - ALWAYS ON ARMED GUARD...
 - DOCTORS PACK HEAT.

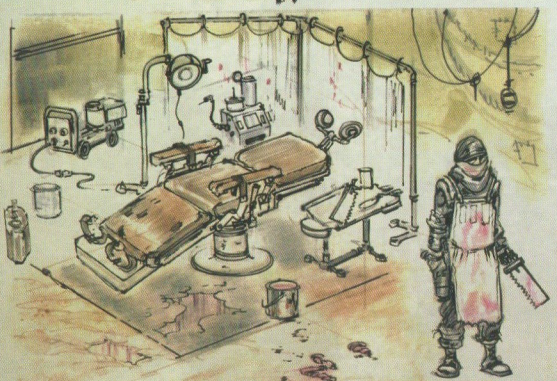
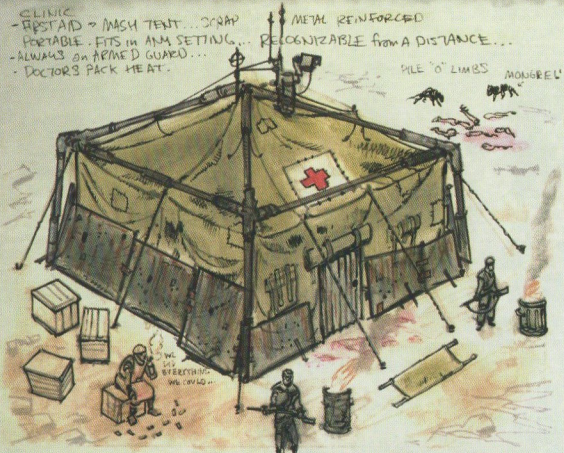

- UNTIL MEDICAL EQUIPMENT... TOOLS.





EDWARD HOPPER
WEDGE APARTMENTS, DINER

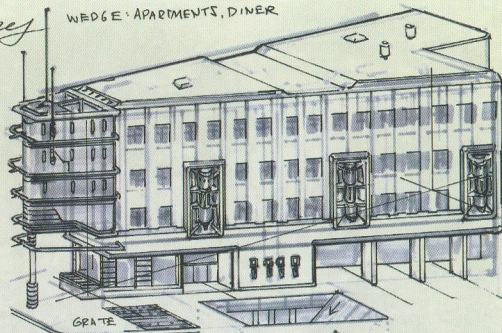

TV Phone Kiosk

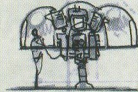

Metro Entrance Canopy
CAP
METRO

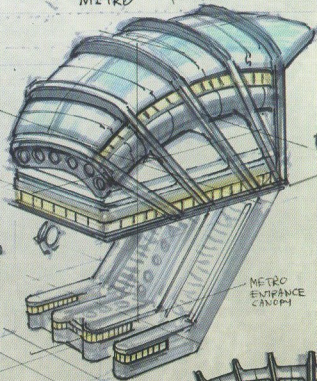

CAUSEWAY: (BUNKER STYLE END CAPS...)

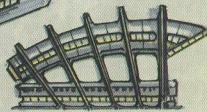
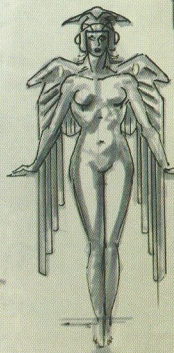
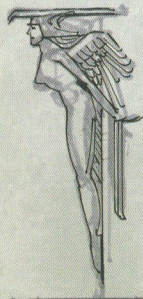
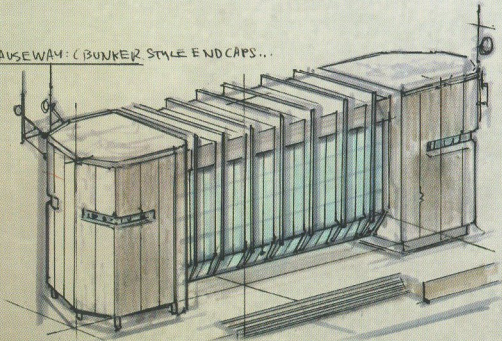

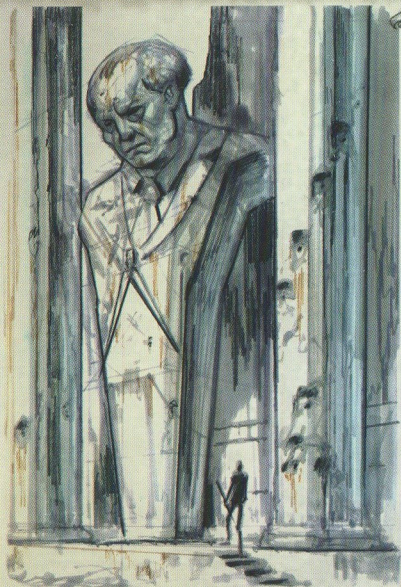

Radio Station facade 1



Chromed-out Valkyries

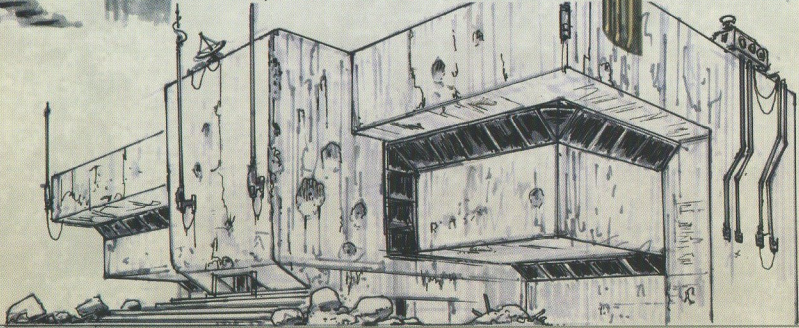



wrecked intersection

BUILDING + MODERN COMMERCIAL
- GARAGES
- GUTTERS
- RAILS
- NOT NEEDED

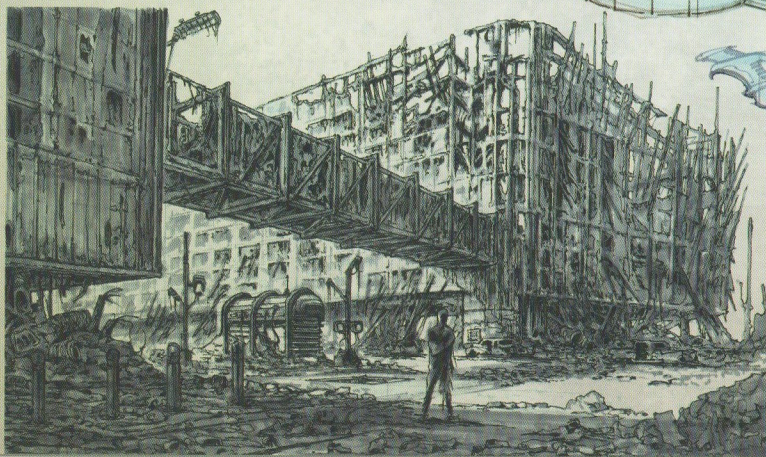
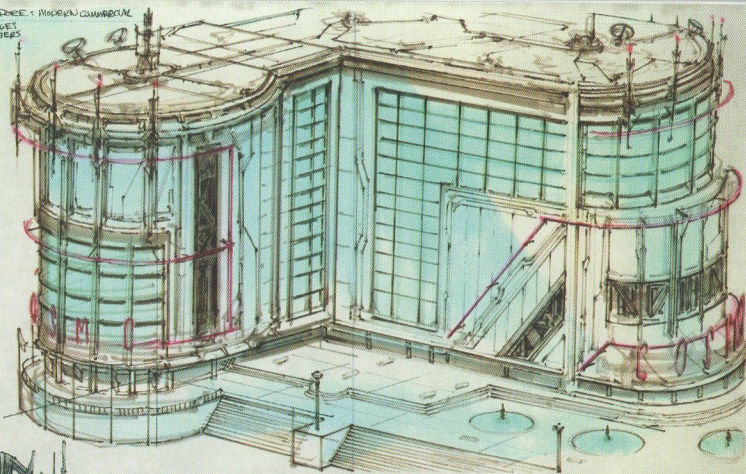

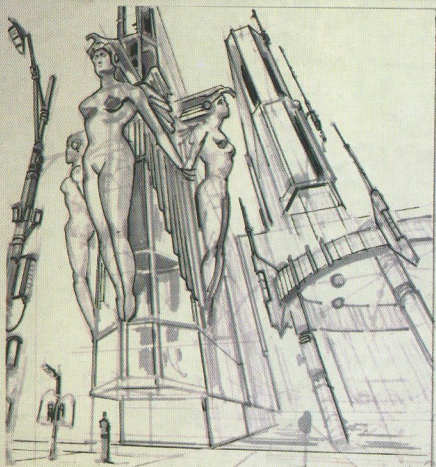

War Memorial

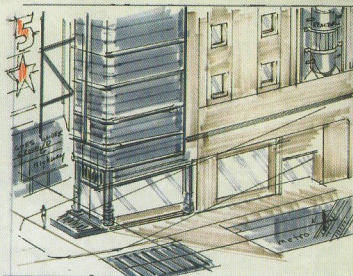

Brooding Metal Deco Heads



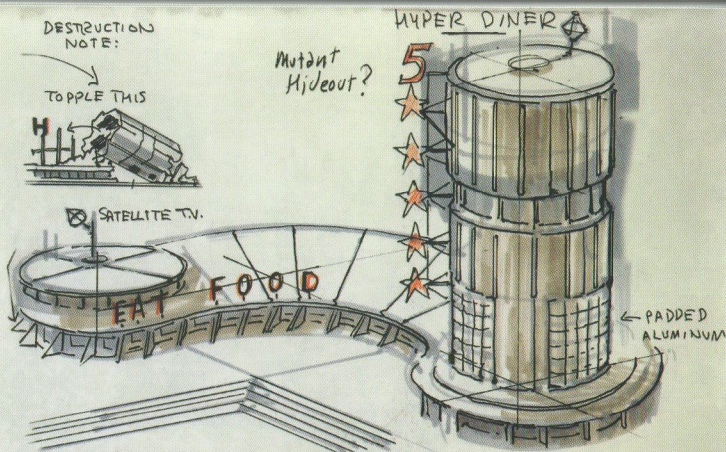

Underworld Entrance Gate

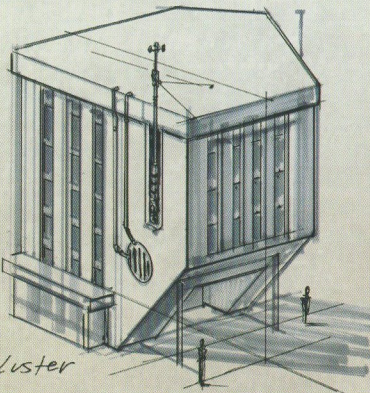
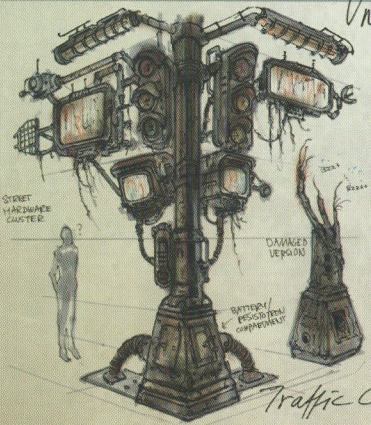

Traffic Cluster

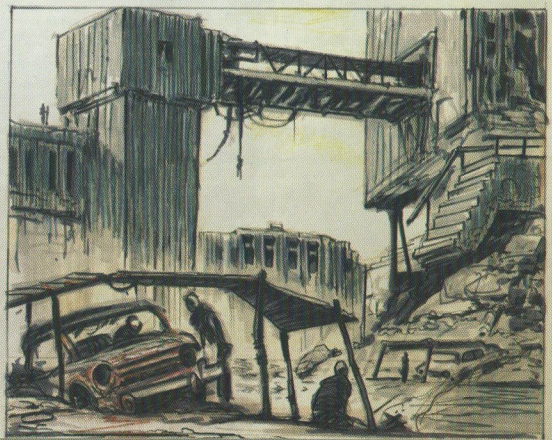



Wreckage Types

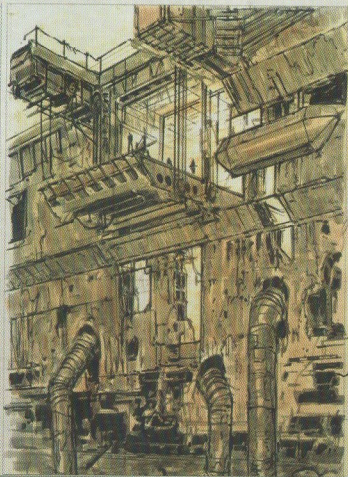
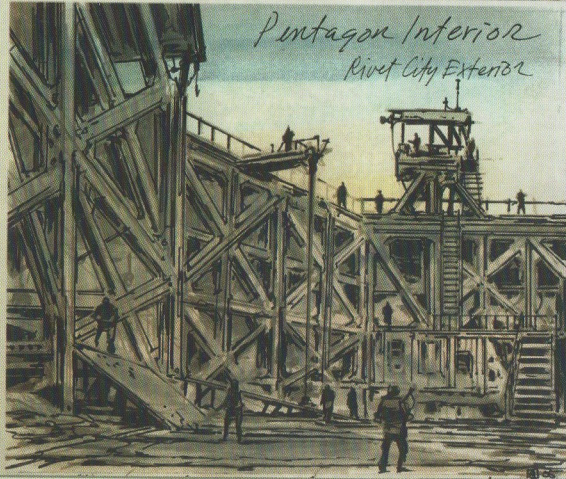
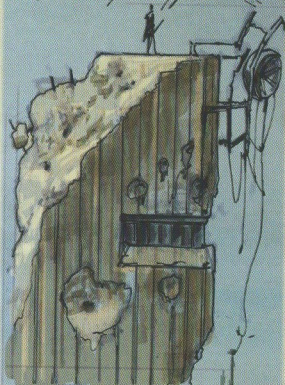

Downtown Vista

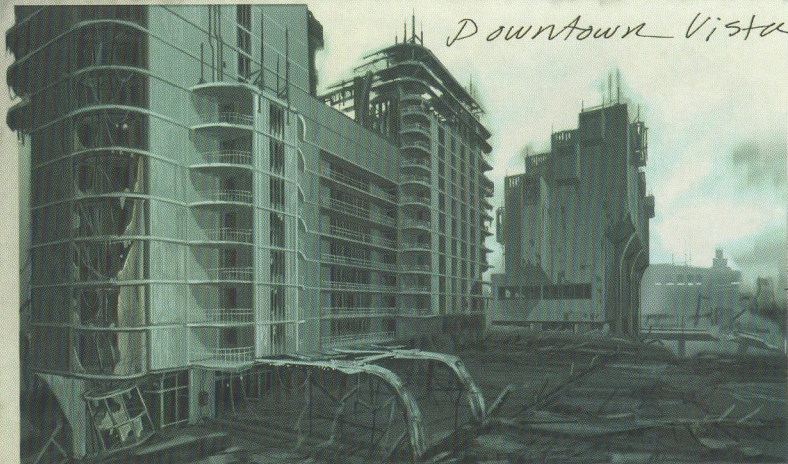

Apartment Ruins

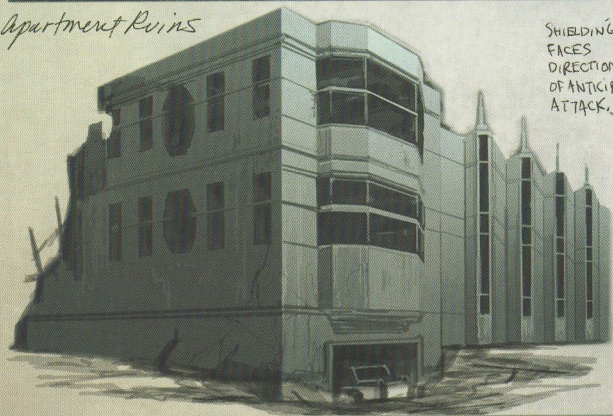

SHIELDING
FACES
DIRECTION
OF ANTICIPATED
ATTACK.

AVOID
"JETSON" inq
designs

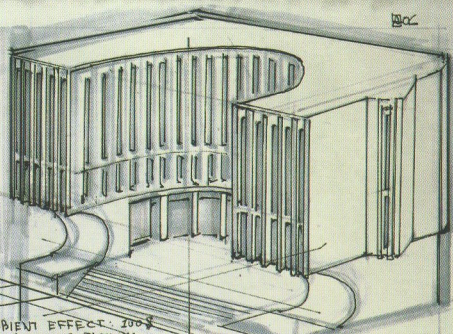
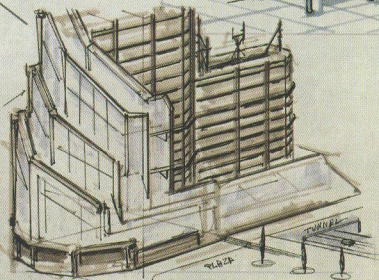

AMBIENT EFFECT: 2000
DOLLAR BILLS BLOW IN
AS PICKUP

ITEM
GOOD
FOR
1. TOILET
PAPER
2. MAKING
FIRES

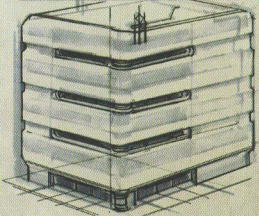
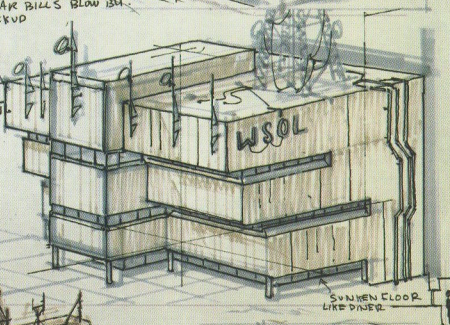

Jefferson Memorial Exterior

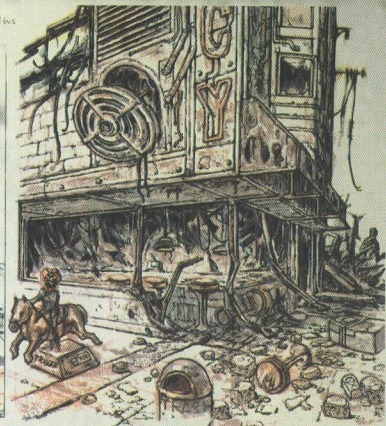
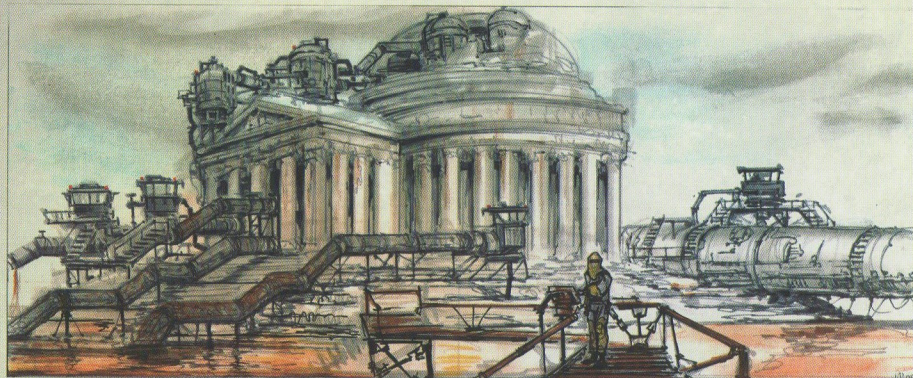

STEEL
SHEATHING
WOODEN
CORE

WOODEN CORE

Street Corner Tower
Types.
Classical U.S. Vents
and Deco-needs

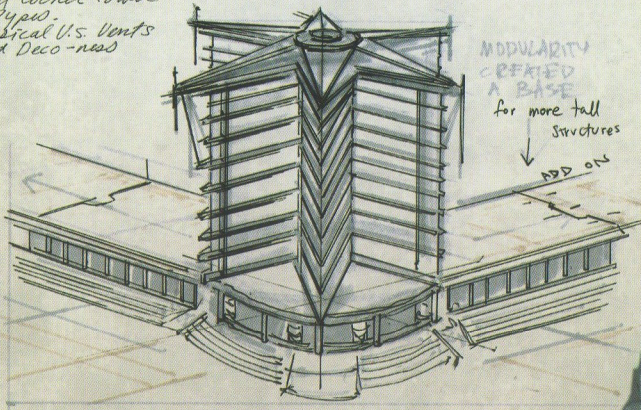
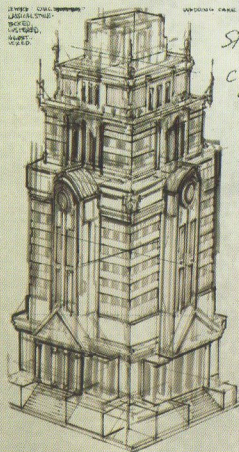

MODULARITY
CREATED
A BASE
for more tall
structures
ADD ON

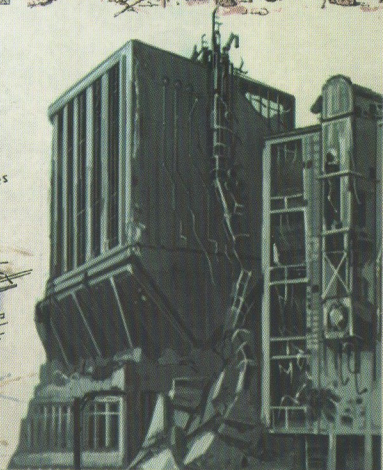

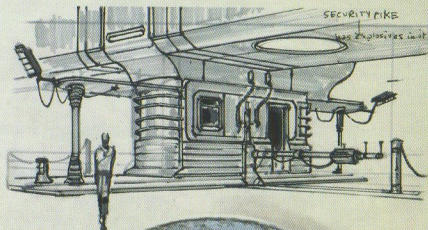
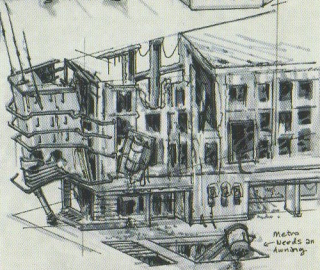
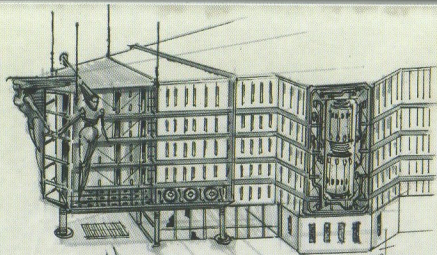
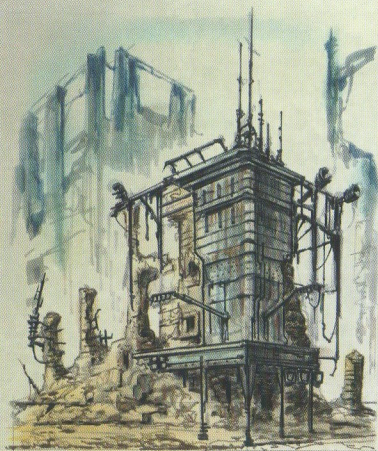

STORYBOARDS

There wasn't a whole lot that we needed to storyboard for this game. Other than the intro movie and ending sequence, there aren't many "cinematic" sequences that play out in a linear manner that would call for such detailed planning. Included here are two key storyboards, however, that were absolutely critical. First is the intro movie that's shown when you start a new game. The first part of this movie, the portion up to the Brotherhood soldier reveal, was the first bit of footage, of any game content in fact, to be revealed to the public at large. This put a lot of pressure on us to make a good first impression. We wanted to do a new, but familiar twist on the intro movie from the first game, and the radio in the bus pull-back sequence was the result.

Although we didn't have cinematics in the game, the reality is that we actually have quite a few, but they're dynamically executed whenever you use the game's V.A.T.S. mechanic (Vault-Tec Assisted Targeting System). The basic design for the system was to have a context-sensitive camera playback of the player's queued combat actions. Included here is the original storyboard for how we envisioned this camera sequence playing-out. And I'm pleased to note that the final result in the game, a few years later, is really not so far off these initial sketches, at least in spirit.

As a whole, much of what Adam has drawn in these pages has made the transition to 3D very faithfully, and I think this is a testament to the clarity of vision and quality of the concept work done from pre-production to the closing days of alpha. I hope you've enjoyed this pocket-sized tour of the art of Fallout 3.

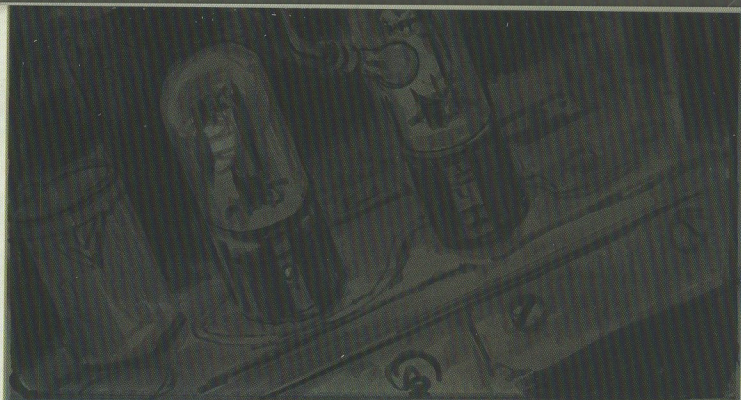

1. Fade in from black 2. Close up of radio innards

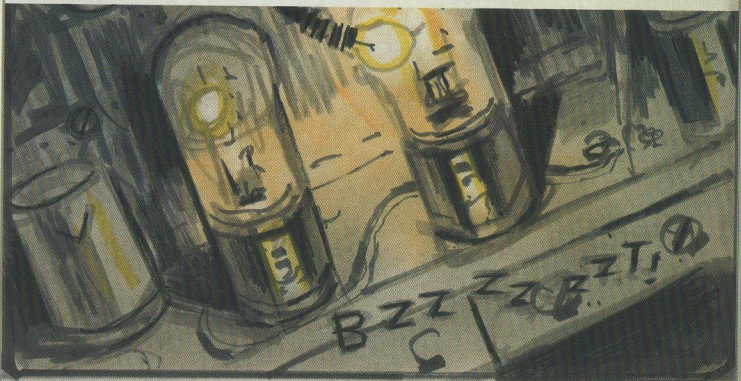

3. Dangling dashboard filament heats up.
SFX: Bzzzzzt. Song starts.4





5. Pan up to singed ornament ruffled by hot breeze through busted windshield.

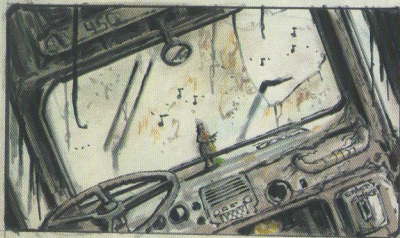

6. Back up to reveal vintage public bus front.

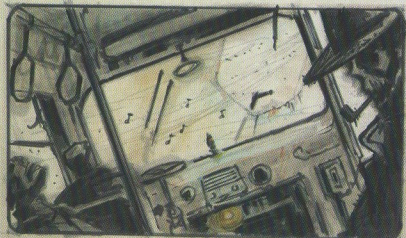

7. Continue backing up to reveal further ruin, gusts blow debris through bus as song continues.



8. pan back, bus adverts, propaganda. dashboard light still visible



9. further destruction, antiquated personal effects litter floor (Titanic wreck discovery)



10. Exit bus, city reveal, song continues but is distorted by ambient wind sounds. Debris blows by.



11. Wide establish shot of destroyed DC location in Fallout 3 universe. Music dopplers, distorts. Monument prominent in bkgrnd with light like bus.

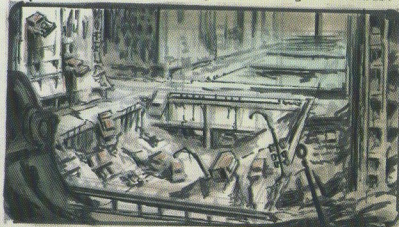

12. Lefthand side dominated by Brotherhood soldier as silhouette. Light on monument and bus fade as does music.

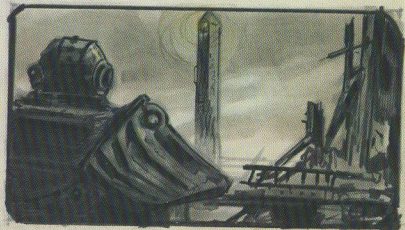

13. reveal Brotherhood of Steel figure, SFX: Harsh helmet radio transmission



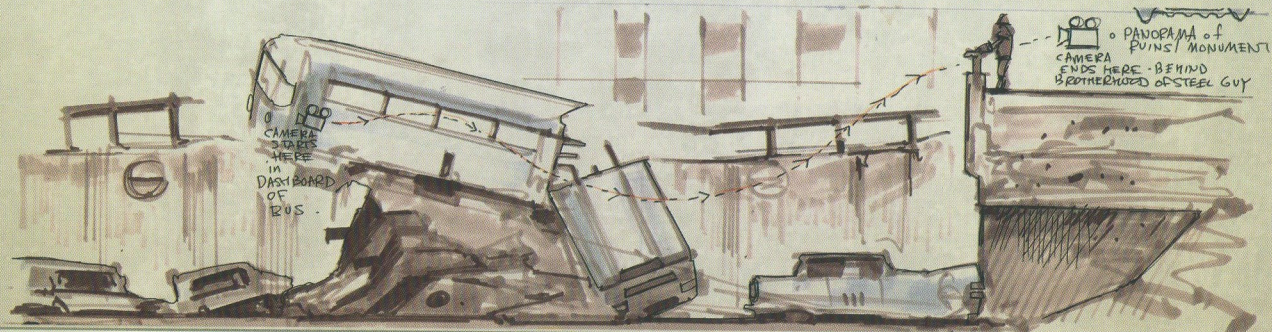
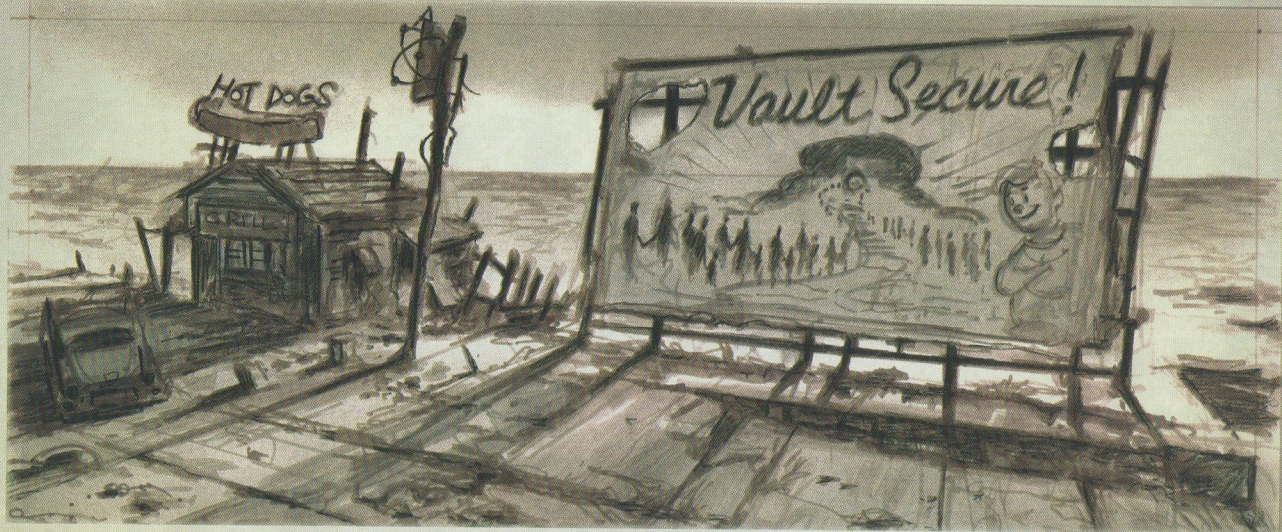



2 Give the dawn of Atomkraft



3 God to justice to simple psychotic rage

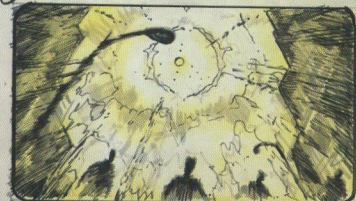

4 In the year 2077... nuclear fire and radiation

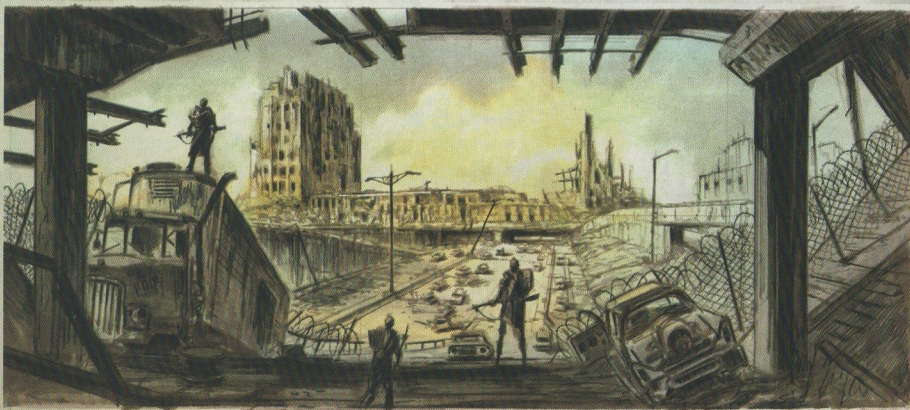

... But it was not the end of the world... war never changes



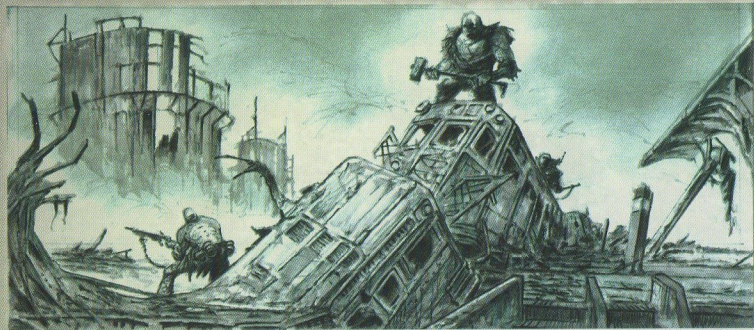

THE FALLOUT 3 ART TEAM

LEAD ARTIST

Istvan Pely

LEAD ANIMATOR

Josh Jones

CONCEPT ART

Adam Adamowicz

ADDITIONAL CONCEPT ART

Craig Mullins

SPECIAL EFFECTS & GORE

Grant Struthers



WORLD ART

Andy Barron

Hope Adams

Noah Berry

Cory Edwards

Tony Greco

Daniel T. Lee

Nate Purkeypile

Rashad Redic

Megan Sawyer

Ryan Sears

Clara Struthers

Rafael Vargas

Robert Wisniewski

ADDITIONAL WORLD ART

Todd Broadwater

Miles Burrell

Matthew Carofano

Cory Dornbusch

Greg Kline

Ryan Salvatore

CHARACTER ART & ANIMATION

Ben Carnow

Jangjoon Cha

Hiu Lai Chong

Jonah Lobe

Gary Noonan

Dane Olds

Juan Sanchez

ADDITIONAL CHARACTER ART & ANIMATION

Liz Beetem

Christiane Meister

Hugh Riley

Massive Black

Liquid Development

ILLUSTRATION

Natalia Smirnova



AOF VTB-026-09c